



# GoFit™

## Booster Car Seat

### User Guide

For future use, STORE USER GUIDE  
in location on bottom of base.

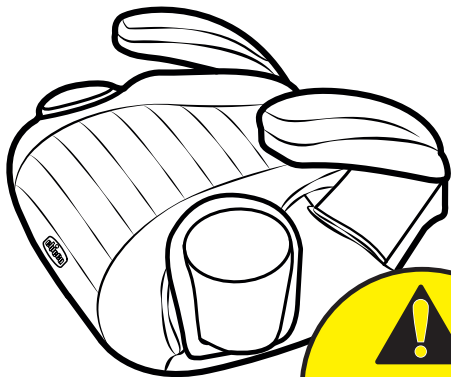

If you have any problems with your Chicco Booster Seat, or any questions regarding installation or use, please call:

**Chicco Customer Service**  
**1-877-424-4226**

Please have Model and Serial Number available when you call. These are located on a label on the bottom of the Booster Seat.

For future reference, fill in the information below. The information can be found on the label on the bottom of the Child Restraint.

Model Number: \_\_\_\_\_

Serial Number: \_\_\_\_\_

Manufactured In: \_\_\_\_\_

## TABLE OF CONTENTS

Registration and Recall	2	<b>BACKLESS BOOSTER MODE</b>	
Child Guidelines	4	Using Shoulder Positioning Clip	24
Safe Use Checklist	6	Install Backless Booster	24
Important Warnings	8	Securing Child in Booster	26
Best Practices	12	Adjusting Shoulder Positioning Clip Height	28
Need Help?	13		
<b>BOOSTER SEAT OVERVIEW</b>			
Booster Seat Components	14	<b>SAFETY INFORMATION</b>	
Backless Booster Mode	16	Secure Child Checklist	32
		Booster Seat Safe Use Checklist	34
<b>VEHICLE INFORMATION</b>			
Vehicle Seating Positions	18	<b>ADDITIONAL INFORMATION</b>	
Vehicle Seat Belts	20	Installation on an Aircraft	36
		Cup Holder	38
		Removing Fabric Covers	40
		Cleaning and Maintenance	50
<b>ASSEMBLY INFORMATION</b>			
Cup Holder Assembly	22		

Please complete the Registration Card that came with your Booster Seat and mail it promptly.

Child Restraints could be recalled for safety reasons. You must register this restraint to be reached in a recall. Send your name, address, e-mail address if available, and the restraint's model number and manufacturing date to:

**Artsana USA, Inc.**  
**1826 William Penn Way**  
**Lancaster, PA 17601**

or call 1-877-424-4226

or register online at <http://www.chiccousa.com/carseatregistration>

For recall information, call the U.S. Government's Vehicle Safety Hotline at 1-888-327-4236 (TTY: 1-800-424-9153), or go to <http://www.NHTSA.gov>.

PAGE INTENTIONALLY LEFT BLANK

## CHILD GUIDELINES

This Booster Seat is designed for children, and who demonstrate an ability to sit in a seat belt.

- **Child can sit relatively still, in the same seated position throughout the car ride.**
- **Child can leave the shoulder and lap belt properly positioned on their body, and can do this every time in the car.**

**ONLY** use this Booster Seat if the child meets the following Weight and Height requirements:

- **Weight is between 40 and 110 pounds (18 and 50 kg).**
- **Height is between 38-57 inches (97-145 cm).**

**⚠ YOUR CHILD'S SAFETY DEPENDS ON YOU!** You **MUST** follow the detailed instructions in this User Guide to ensure the steps in this User Guide are performed correctly!

## CHILD GUIDELINES



40 lbs  
(18 kg)

110 lbs  
(50 kg)



Backless Booster Mode  
on page 16.

## SAFE USE CHECKLIST

- Make sure your child can sit in the seat properly and meets the requirements listed in the "Child Guidelines" section on page 4:

**BACKLESS BOOSTER MODE** requirements on page 16

### Select a safe seating location in your car:

- Refer to the "Vehicle Seating Positions" section on page 18 and 19.

### Secure your child:

- Refer to the "Safety Information" section on page 32.

## SAFE USE CHECKLIST





**FAILURE TO FOLLOW THESE INSTRUCTIONS AND THE PRODUCT LABELS CAN RESULT IN SERIOUS INJURY OR DEATH TO YOUR CHILD.**

### **Take Time to Read This User Guide**

- Carefully read and understand all instructions and warnings in this User Guide. Your child's safety depends on you knowing how to setup, install and use this Booster Seat properly.
- Before installing this Booster Seat in a vehicle, be sure to also check the vehicle owner's manual for information on proper installation.
- **NEVER** allow others to use this Booster Seat until they have read and understood all instructions in this User Guide.
- This Booster Seat is not intended for use outside of the vehicle.

### **Make Sure Child Fits This Booster Seat**

- Use **ONLY** with children who weigh between 40 lbs (18 kg) and 110 lbs (50 kg) and whose height is 38-57 inches (97 -145 cm). **AND** has the ability to sit properly at all times.



### **Install Child Restraint Correctly**

- **DO NOT PLACE THIS BOOSTER SEAT IN A VEHICLE SEATING LOCATION WITH A FRONTAL AIR BAG, UNLESS THE AIR BAG CAN BE TURNED OFF.** If the airbag inflates, it can cause serious injury or death to your child. For vehicles with side air bags, refer to you vehicle owners manual for information on your booster seat installation.
- **ALWAYS** install this Booster Seat in a back seat if possible.

According to accident statistics, children are safer when properly restrained in a rear seating position rather than in the front seat.

- **NEVER** install in rear facing, side facing or on the back of a folded down vehicle seat.
- **NEVER** use this Booster Seat with only a Vehicle Lap Belt.
- Use **ONLY** the vehicle's Lap-Shoulder Belt system when restraining a child in this Booster Seat.
- To avoid injury to others, **ALWAYS** secure this Child Restraint with the vehicle's Lap-Shoulder Belt when **unoccupied**.
- **DO NOT** use this Booster Seat beyond the "Do Not Use After" date. Check manufacturer's label on underside of Booster Seat.



### Secure Child Properly

- Position Lap-Shoulder Belt on your child. A loose or improperly positioned Lap-Shoulder Belt could cause the child to be ejected in a sudden stop or crash, resulting in serious injury or death.
- Make sure vehicle Lap-Shoulder Belt is not loose. The belt must be kept snug across child's thighs and resting on the shoulder and across the center of the chest.
- **NEVER** use clothing or blankets that interfere with fastening or tightening the Lap-Shoulder Belt. An unsecured child could be ejected in a sudden stop or crash!
- **ALWAYS** check to make sure the vehicle seat buckle is securely latched.
- **NEVER leave your child unattended in the vehicle.**
- Do not allow children to play in or around the Booster Seat.



### Check Condition of Restraint

- **DO NOT** use if the vehicle belts are cut, frayed or damaged.
- **DO NOT use any accessories, pads or products not included with this Booster Seat, unless approved by Chicco USA.** Doing so will void the warranty of this Booster Seat.
- You **MUST** replace this Booster Seat if it has been involved in a crash, even if you cannot see visible damage. A damaged Booster Seat may not protect your child in a future crash.
- **Do not modify your Booster Seat.**
- **Do not use Booster Seat if any component is damaged, broken, or missing.** Call 1-877-424-4226 to find out if the damaged part or parts can be replaced.

- Ensure all vehicle occupants are properly restrained before traveling. Unrestrained occupants can be thrown around and may be seriously injured or seriously injure other occupants in a sharp turn, sudden stop or crash.
- Do not leave loose objects, such as books, bags, etc., in the back of the vehicle. In the event of a sharp turn, sudden stop, or crash, loose objects can be thrown around and possibly cause serious injury to vehicle occupants.
- Cover the Booster Seat when the vehicle is parked in sunlight. Parts of a Booster Seat can become very hot if left in the sun. Contact with these parts can burn a child's skin. Always check the surface of any metal or plastic parts before putting your child in the Booster Seat.
- To avoid strangulation, Do not allow children to play with vehicle seat belts. If possible, move unused belts out of reach.
- Do not use anything to raise the Booster Seat off the vehicle seat. In a sharp turn, sudden stop, or crash, the Booster Seat could slide and potentially cause serious injury.
- Never use a second-hand Booster Seat with an unknown history.
- Never use any accessories that are not included with this child restraint, unless specifically approved by Chicco. For more information, go to [www.chiccousa.com/accessories](http://www.chiccousa.com/accessories).

### **Need Help Securing Your Booster Seat?**

The following sources are available to help ensure your Booster Seat is properly installed:

- Contact Chicco, USA by visiting our website at [www.chiccousa.com](http://www.chiccousa.com) or calling our Customer Service 1-877-424-4226. Please have Model and Serial Number available when you call. These are located on a label on the bottom of the Booster Seat.
- Refer to your vehicle manual for Booster Seat installation tips.
- Contact a certified Child Passenger Safety Technician in your area by visiting [safercar.gov](http://safercar.gov) and select "Find Local Child Seat Help" or call 1-866-SEAT CHECK (1-866-732-8243).



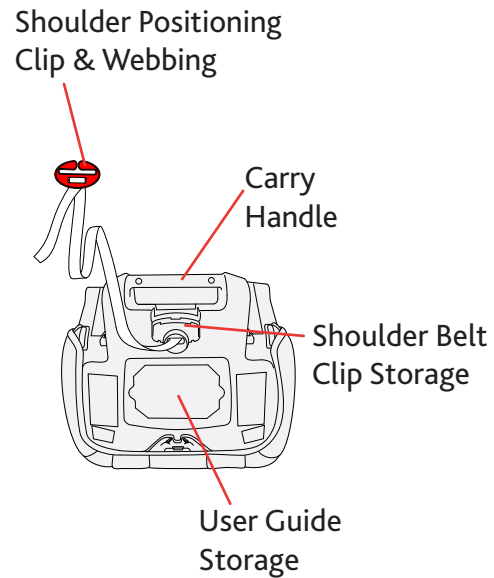
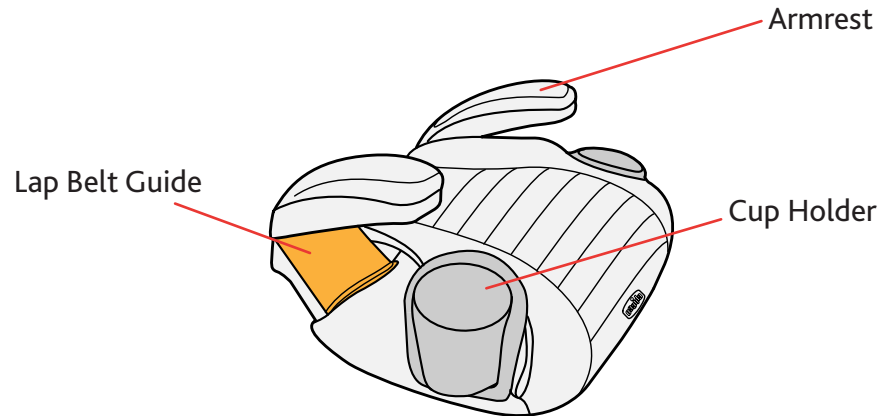

## BACKLESS BOOSTER MODE

**▲ WARNING!** **Backless Mode** use of this Booster Seat is ONLY for children who meet ALL of the requirements shown here. If the child is not within these requirements because the child is too small, select a different child seat.

To ensure a correct installation of the Booster Seat, you must follow the step by step instructions in this user guide.

Chicco and the American Academy of Pediatrics recommend that children ride in a car seat with a 5-point harness for as long as possible. For the best protection, keep the child in a car seat with a 5-point harness up to the highest weight or height allowed by the manufacturer.

## BACKLESS BOOSTER MODE

**Backless Booster Mode:**  
**40 – 110 lbs (18 – 50 kg)**

Use **Backless Mode** with children:

- Who are at least four years old.
- Who weigh between 40 and 110 lbs (18 – 50 kg).
- Who are 38" - 57" (97 -145 cm) tall, child's ears are below vehicle seat.
- Who demonstrate an ability to sit relatively still and properly in a seat belt at all times.

See Adjusting Shoulder Positioning Clip Height on page 28.





**▲ IMPORTANT! WHEN USING THIS CHILD RESTRAINT, DO NOT PLACE THIS BOOSTER SEAT IN A VEHICLE SEATING LOCATION WITH A FRONTAL AIR BAG, UNLESS THE AIR BAG CAN BE TURNED OFF.**

The back seat is the safest place for children 12 and under. See your vehicle owner's manual for Booster Seat installation and instructions.

Some vehicles have no seating positions which are compatible with this Booster Seat. Only forward-facing vehicle seats can be used with this Booster Seat. Never use side or rear facing seats. If in doubt, contact the vehicle manufacturer for assistance.



This Booster Seat must be installed in a vehicle seat with a 3-point seat belt (shoulder belt and lap belt). **NEVER** use lap belt only.



Vehicle seat belts differ from vehicle to vehicle. Refer to your vehicle owner's manual for specific information about seat belts and their use with booster seats.

**Shoulder belt with switchable retractor:**

Refer to your vehicle owners manual for information regarding switchable retractors and booster seat use.

**Inflatable seat belts:**

Follow the vehicle manufacturer's instructions for use with this Booster Seat.

The following types of vehicle belts **MUST NOT** be used to install this **Booster Seat**.

If any of the belt types listed below are in the chosen seating position, you must choose another vehicle seating position.

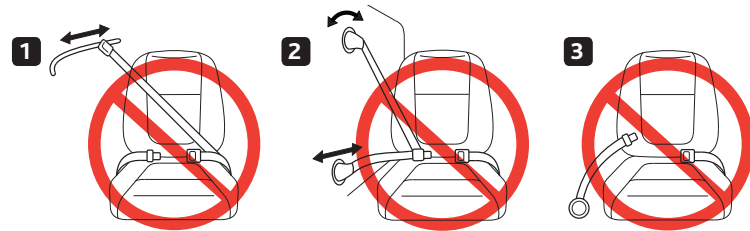

**1. Never** use a Lap belt with motorized Shoulder belt. **3. Never** use a Lap-only belt.

**2. Never** use vehicle belts that are attached to the door or that move along a track.

**1 Assemble the Cup Holder**

- 1** Match up the letter (L or R) on the bottom of the Cup Holder with the matching letter on the Booster Seat and insert the Cup Holder into the correct side.

Make sure the Cup Holder lip fits behind the groove on the Booster Seat bottom, as shown.

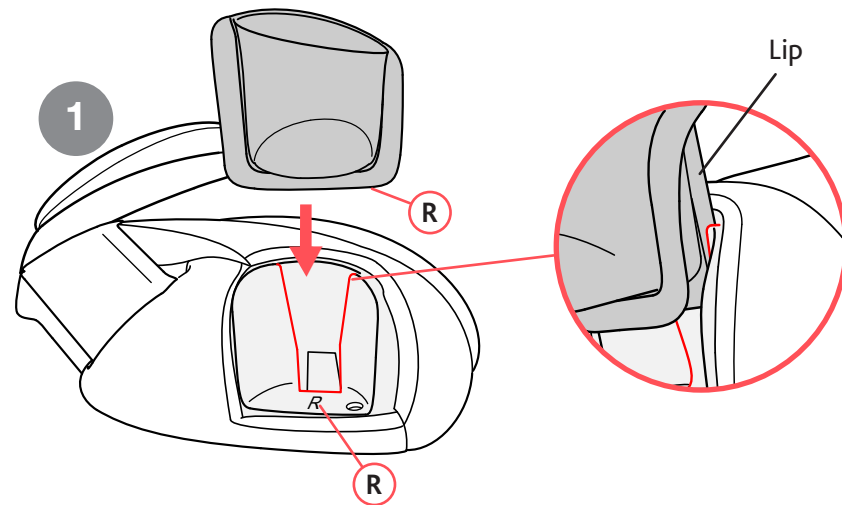

## USING SHOULDER POSITIONING CLIP

- 1 The Shoulder Positioning Clip is stored under the Booster Seat. Remove the Shoulder Positioning Clip and Strap stored underneath seat.
- 2 Place the Booster Seat onto the vehicle seat.

## USING SHOULDER POSITIONING CLIP

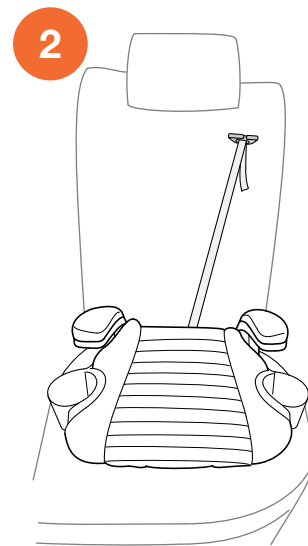
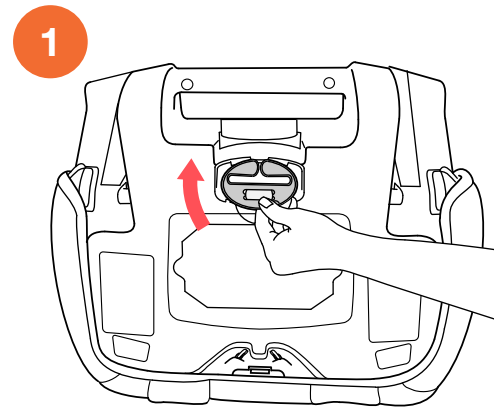

## SECURING CHILD IN BOOSTER

- 1 Place the child into the Booster, making sure the child is sitting with his/her back against the vehicle seat back.

*Child's ears must be below vehicle seat back or vehicle head restraint when sitting on Booster Seat. Refer to page 17.*

- 2a Route the lap belt **UNDER** the 1st Armrest, across the child's thighs, Then route the shoulder belt and the lap belt **UNDER** the 2nd Armrest closest to the vehicle buckle as shown. Lap-Shoulder belts **MUST** be under **ARMRESTS**.
- 2b Buckle the seat belt.

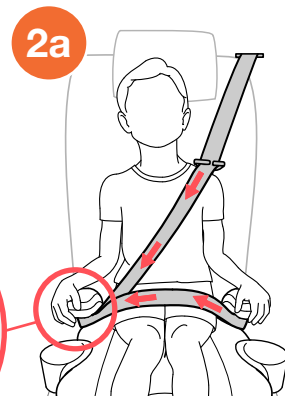
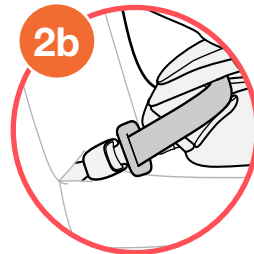

## SECURING CHILD IN BOOSTER

- 3 To adjust the Shoulder Positioning Clip. Pull the clip up or down to adjust the Shoulder Positioning Clip to be at child's shoulder.
- 4 Slide the vehicle shoulder belt through the Shoulder Positioning Clip (as shown). Shoulder Positioning Clip must be at child's shoulder. If necessary, re-adjust the location of the Clip to ensure that the seat belt lays flat and snug across the child's chest and the lap belt lays flat and snug across the child's thighs.

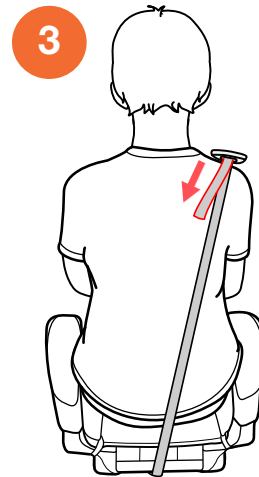

## SECURING CHILD IN BOOSTER

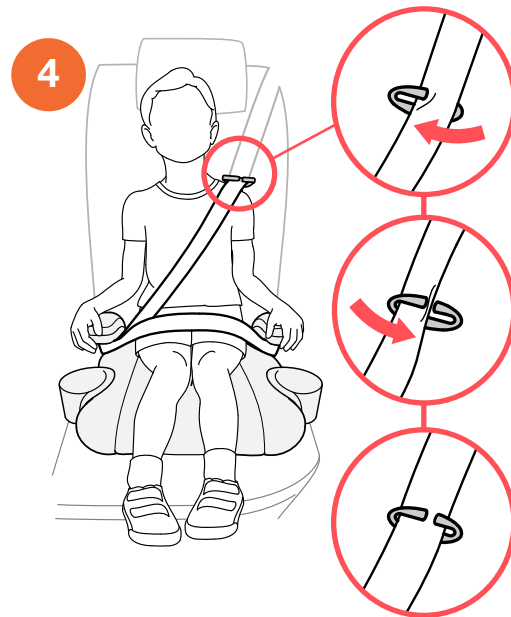



## SECURING CHILD IN BOOSTER

- 5 Child is now secured correctly, as shown.

When using this Booster, you must use the Shoulder Positioning Clip until the seat belt naturally lays flat across the center of the child's shoulder.

## SECURING CHILD IN BOOSTER

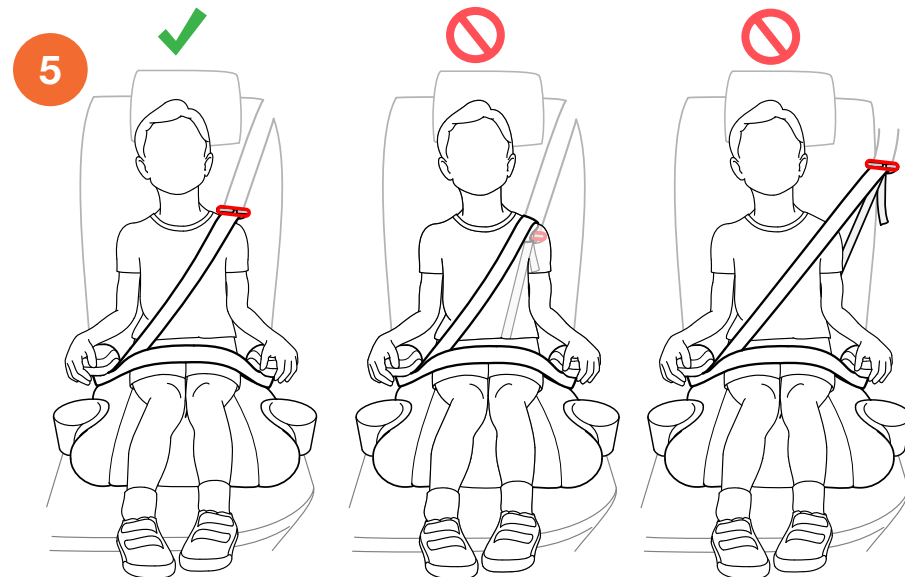

## SECURING CHILD CHECKLIST

⚠ **ALWAYS** check to make sure vehicle seat belt is securely buckled. If buckle separates, child could be killed or seriously injured.

- ✓ Check that the seat belt is not twisted.
- ✓ Check that the shoulder belt is snug on the child's shoulder and that it does not rub on the neck. It should lie flat across the child's chest and middle of shoulder. The Shoulder Positioning Clip must be positioned at child's shoulder

⚠ **DO NOT** use anything (pillows, blankets, etc.) between the Booster and the vehicle seat or between the child and the Booster. Avoid bulky clothing that interferes with proper seat belt placement. In the event of an accident, the Booster may not operate correctly.

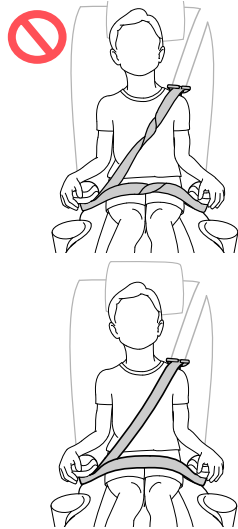

## SECURING CHILD CHECKLIST

- ✓ Do not let your child slide forward or downward while in the Booster.



- ✓ Never use the vehicle belt in any position other than those indicated in this User Guide!

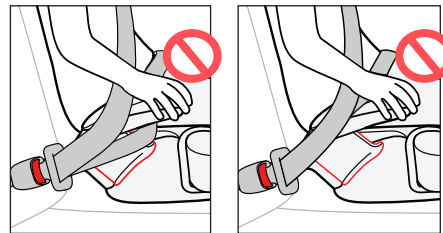

## BOOSTER SEAT SAFE USE CHECKLIST

▲ To avoid injury to others, ALWAYS secure this Booster Seat when unoccupied. An unsecured Booster Seat could injure other occupants in a sudden stop or crash.

Secure the unoccupied Booster with the vehicle belt by following the "Secure Child in Booster" instructions. The Lap-Shoulder belt should be used to secure the Backless Booster seat.

- 1 Follow steps 1-4 to use Lap-Shoulder belt page 26.

## BOOSTER SEAT SAFE USE CHECKLIST

1

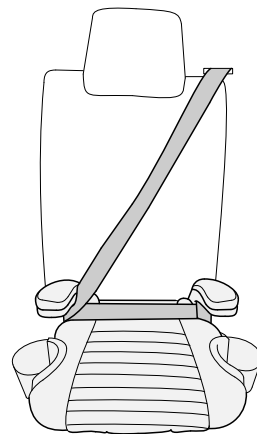

## INSTALLATION ON AN AIRCRAFT

- This Booster Seat is NOT certified for use on aircraft. Aircraft do not have lap-shoulder belts to secure your child.

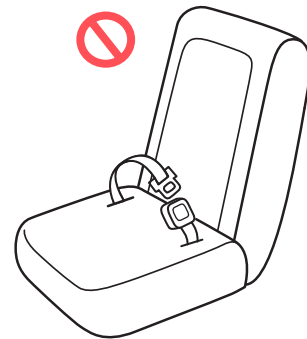
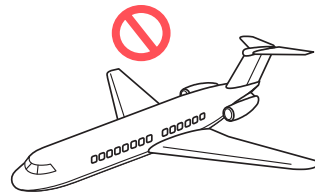

## CUP HOLDER

**⚠ WARNING!** DO NOT place hot liquids in cup holder. If spilled, hot liquids could burn child. **PLASTIC CONTAINERS ONLY** - No glass or metal containers. Only use cups with less than 12 oz. capacity. Never place sharp or pointed objects in Cup Holder. In a crash these objects could hit you or your child and cause serious injuries.

- 1** To remove the Cup Holders press in on the release button on the bottom of the Booster Seat.
- 2** The Cup Holders can also be folded in to allow others to sit next to the Booster Seat.

## CUP HOLDER

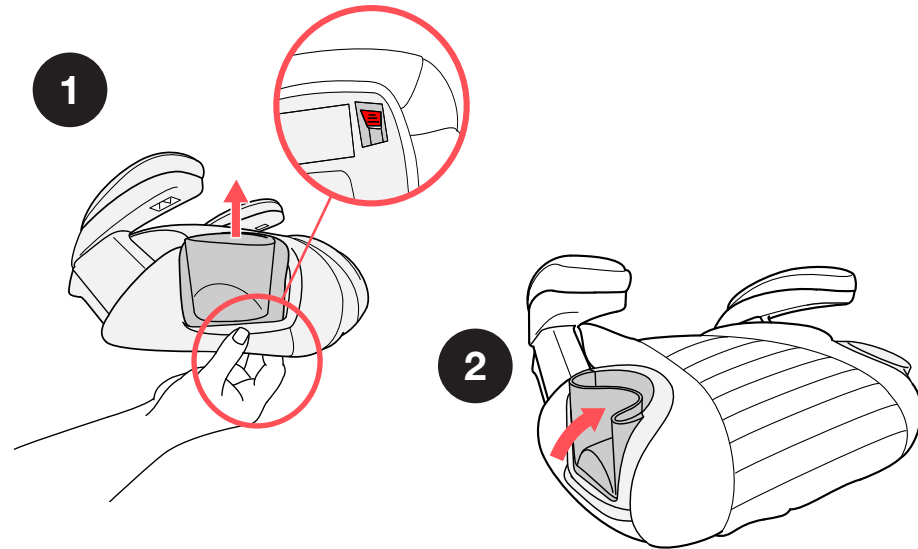

## REMOVING FABRIC COVERS

- 1** **Booster Seat bottom**  
Remove both Cup Holders and flip the Booster Seat bottom over and unhook 6 elastic loops, as shown.

*Both Cup Holders need to be removed before you can remove the fabric, refer to page 38.*

## REMOVING FABRIC COVERS

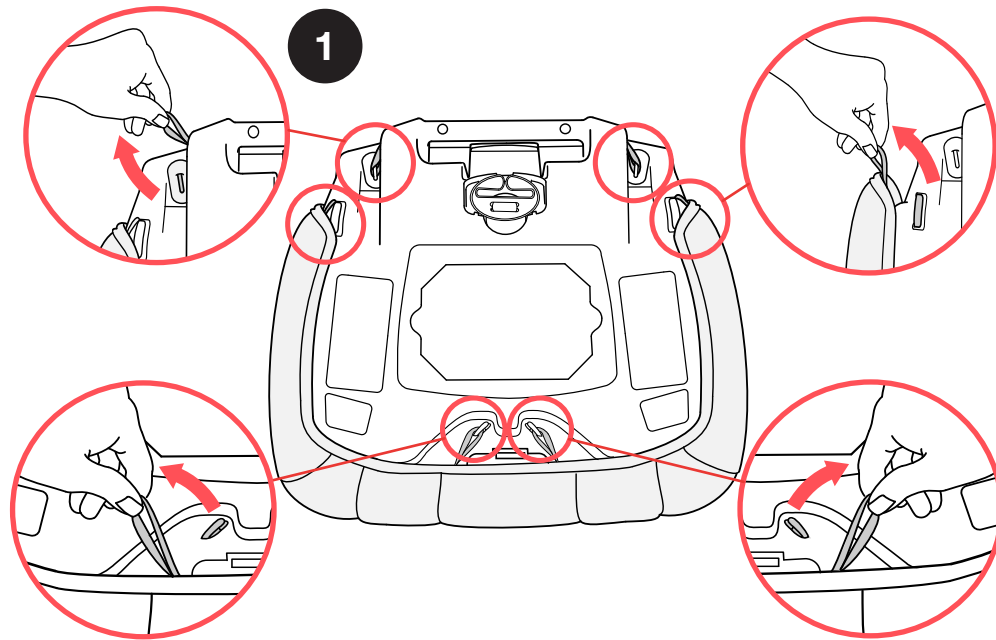

## REMOVING FABRIC COVERS

- 2 Flip the fabric over and remove the Insert before you wash the fabric. Make sure to reinstall the Insert into the fabric seat bottom before you reinstall onto the seat bottom frame.

## REMOVING FABRIC COVERS

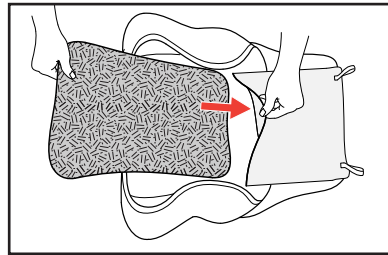
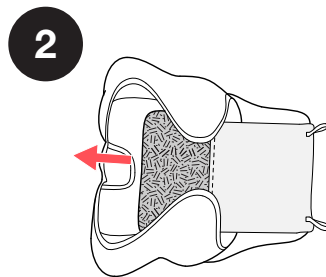

## REMOVING FABRIC COVERS

Repeat **Removing Fabric** steps in the reverse order, ensuring that the fabric cover fits onto and around the frame correctly, in particular around the orange belt guides.

The Insert **MUST** be reinstalled into the seat bottom fabric, see page 42.

- 1 Position the fabric cover on the Booster Seat bottom and tuck in the fabric along the belt guide edges. Flip the seat bottom over. Then tighten the fabric over the Booster Seat bottom further by reattaching the elastic loops, as shown.

**▲** Be sure to fit fabric cover carefully around all orange belt guides. The Booster Seat must **NEVER** be used without the fabric cover. It may not perform as intended in the event of a crash.

## REMOVING FABRIC COVERS

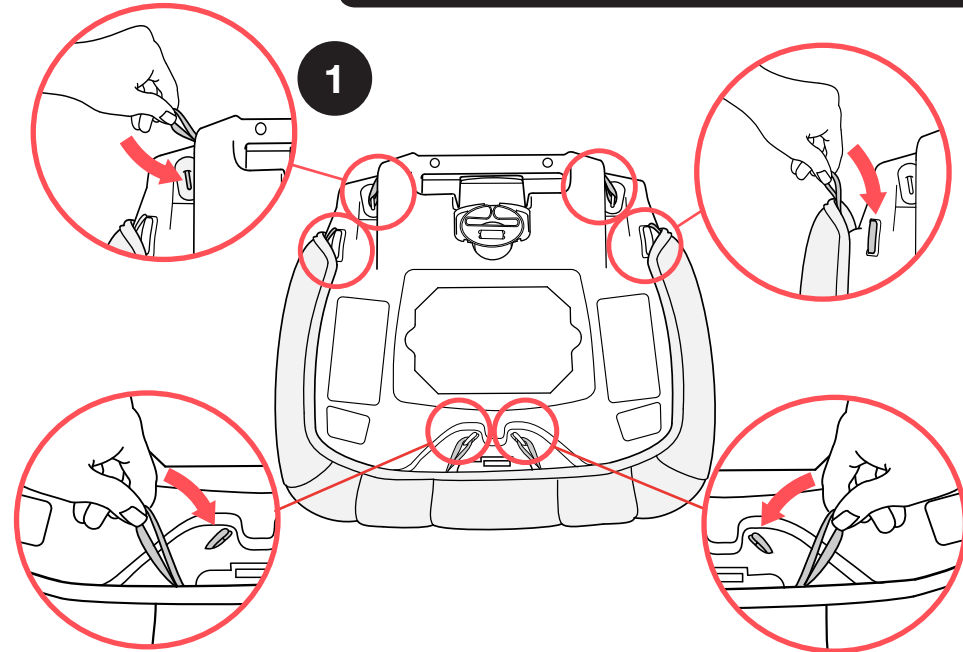



## REMOVING ARMREST COVERS

1

### Armrest covers

Locate the Armrest release button directly under the front of the Armrest. Pull on the button and at the same time lift up on the front edge to remove the Armrest pad.

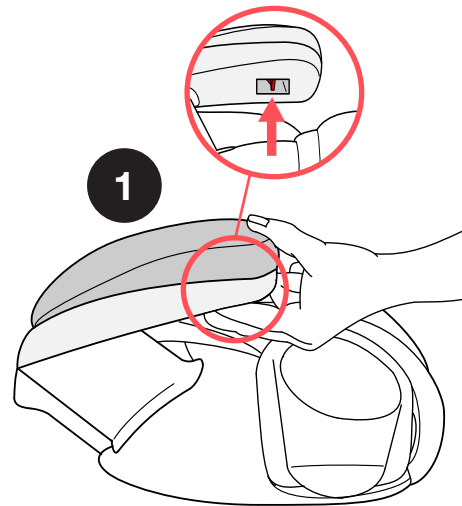

## REMOVING ARMREST COVERS

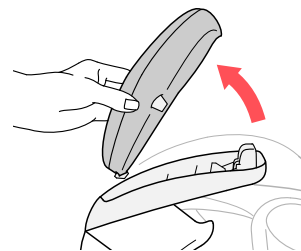

## REMOVING ARMREST COVERS

- 2 Pull back on the edges of the Armrest fabric covers and slide the fabric off the Armrest base.
- 3 To reattach the Armrest, insert the Back Tab into the Armrest base and push down on the front edge until it clicks into the base.

**NEVER** use seat without Armrest fabric covers.

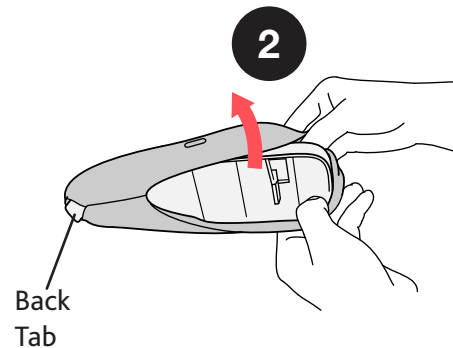

## REMOVING ARMREST COVERS

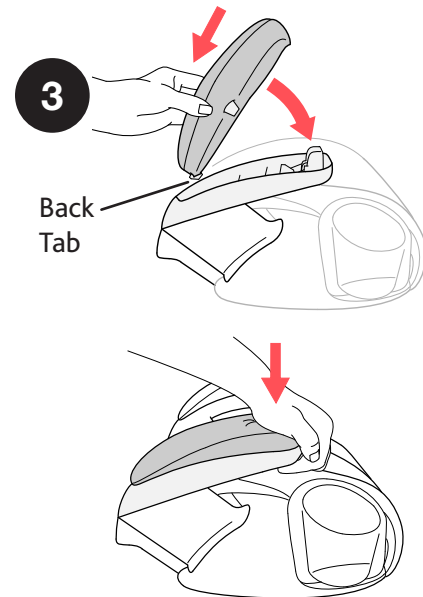

▲ DO NOT USE BLEACH, solvents or household cleaners as they may weaken plastics and straps.

▲ DO NOT USE SOAPS OR LUBRICANTS on Lower Anchor Connector hardware. It may cause them to malfunction.

- **Fabrics may be spot-cleaned:**  
Hand wash using mild soap and water, or machine washed in cold water on delicate cycle using mild detergent. Hang to dry. See page 40 for removal instructions.
- **Foam Insert:**  
Hand rinse and air dry.
- **Cleaning Plastics:**  
Sponge clean using warm water and mild soap. Towel dry.

- **Storing the Booster:**  
When it is not installed in the car, it is recommended to store the Booster in a dry place, away from sources of heat, dust, humidity and direct sunlight.

