



Nextfit™

Convertible Car Seat

User Guide

For future use, STORE USER GUIDE
in compartment at rear of base.

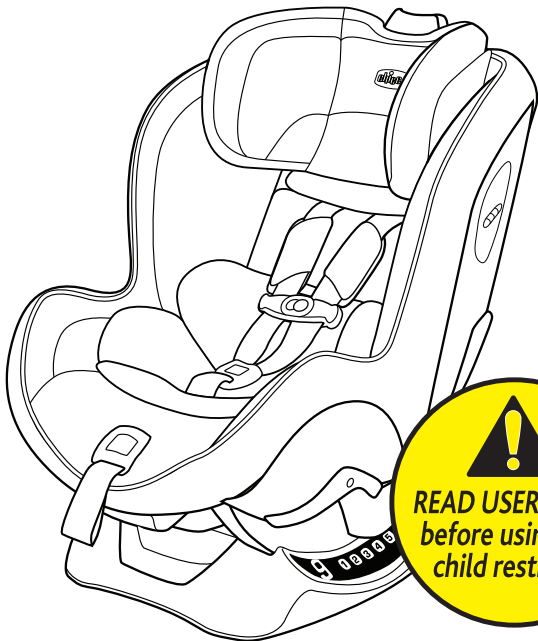
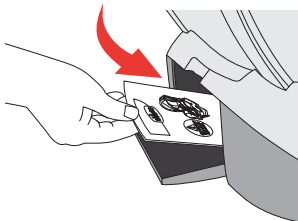

If you have any problems with your Chicco Child Restraint, or any questions regarding installation or use, please call:

Chicco Customer Service
1-877-424-4226

Please have Model and Serial Number available when you call. These are located on a label on the bottom of the Child Restraint.

For future reference, fill in the information below. The information can be found on the label on the bottom of the Child Restraint.

Model Number: _____

Serial Number: _____

Manufactured In: _____

TABLE OF CONTENTS

Registration and Recall	2
Child Guidelines	4
Safe Use Checklist	6
Important Warnings	8
Best Practices	14
Need Help?	15

CHILD RESTRAINT OVERVIEW

Child Restraint Components	16
LATCH and Tether Components	18
LATCH and Tether Storage	20
Selecting Rear/Forward Facing Position	22
Adjusting Crotch Strap	26
Newborn Insert	28

VEHICLE INFORMATION

Vehicle Seating Positions	30
Vehicle Seat Belts	32
What is LATCH?	34
What is a Tether?	36

REAR-FACING INSTALLATION

Rear-Facing Setup	38
Install Using LATCH	42
Install Using LAP-SHOULDER BELT	46
Install Using LAP BELT ONLY	52

FORWARD-FACING INSTALLATION

Forward-Facing Setup	56
Install Using LATCH	60
Install Using LAP-SHOULDER BELT	66
Install Using LAP BELT ONLY	72

SECURING YOUR CHILD

Securing Child with Harness	76
Secure Child Checklist	88

ADDITIONAL INFORMATION

Installation on an Aircraft	90
Cup Holder	92
Cleaning and Maintenance	94

REGISTRATION AND RECALL

Please complete the Registration Card that came with your Child Restraint and mail it promptly.

Child Restraints could be recalled for safety reasons. You must register this restraint to be reached in a recall. Send your name, address, e-mail address if available, and the restraint's model number and manufacturing date to:

Artsana USA, Inc.
1826 William Penn Way
Lancaster, PA 17601
or call 1-877-424-4226

or register online at <http://www.chiccouusa.com/carseatregistration.aspx>

For recall information, call the U.S. Government's Vehicle Safety Hotline at 1-888-327-4236 (TTY: 1-800-424-9153), or go to <http://www.NHTSA.gov>.

PAGE INTENTIONALLY LEFT BLANK

CHILD GUIDELINES

This Child Restraint is designed for children ages Birth to 6 years old. **ONLY** use this Child Restraint if the child meets **BOTH** of the following Weight and Height requirements:

- **Weight is between 5 and 65 pounds (2.2 and 29.4 kg).**
- **Height is 49 inches (1245 mm) or less.**

The Newborn Insert is only for infants who weigh between 5 and 11 pounds (2.2 and 5 kg). See Newborn Insert on page 28.

⚠ For premature infants, you must consult the infant's doctor before using this Child Restraint. A premature infant may have difficulty breathing or have other medical problems when placed in a seated position.

CHILD GUIDELINES

See Select
Rear-Facing
on page 22.

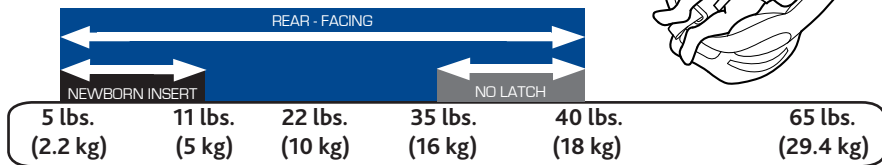

See Select
Forward-Facing
on page 24.



SAFE USE CHECKLIST

⚠ YOUR CHILD'S SAFETY DEPENDS ON YOU! You **MUST** follow the detailed instructions in this User Guide to ensure the steps below are performed correctly!

- Make sure your child meets the age, weight, and height requirements:**
Refer to the "Child Guidelines" section on page 4.

- Choose the proper Child Restraint configuration:**

REAR-FACING requirements on page 22

FORWARD-FACING requirements on page 24

- Select a safe seating location in your car:**
Refer to the "Vehicle Seating Positions" section on page 30 and 31.

- Ensure that the Child Restraint is properly leveled when installed:**

REAR-FACING requirements on page 40

FORWARD-FACING requirements on page 58

- Check Child Restraint for a snug fit in your car:**
While holding Child Restraint near belt path used, pull side to side and forward. Belt should remain tight and Child Restraint should not move more than 1" (25 mm) from vehicle seat back or side-to-side.
- Secure your child:**
Refer to the "Securing Your Child" section on page 76.

IMPORTANT WARNINGS



FAILURE TO FOLLOW THESE INSTRUCTIONS AND THE PRODUCT LABELS CAN RESULT IN SERIOUS INJURY OR DEATH TO YOUR CHILD.

Take Time to Read This User Guide

- Carefully read and understand all instructions and warnings in this User Guide. Your child's safety depends on you knowing how to setup, install and use this Child Restraint properly.
- Before installing this Child Restraint in a vehicle, be sure to also check the vehicle owner's manual for information on proper installation.
- **NEVER** allow others to use this Child Restraint until they have read and understood all instructions in this User Guide.
- This Child Restraint is not intended for use outside of the vehicle.

Make Sure Child Fits This Child Restraint

- Use only with children who weigh between 5 lbs (2.2 kg) and 65 lbs (29.4 kg) and whose height is 49 inches (1245 mm) or less. Determine the right installation setup for your child's age, weight and height.
- **ONLY USE** the Newborn Insert in REAR-FACING and only if the child weighs between 5 and 11 lbs (2.2 and 5 kg).

IMPORTANT WARNINGS



Secure Child Properly

- Snugly adjust the harness around your child. A loose harness could cause the child to be ejected in a sudden stop or crash, resulting in serious injury or death.

A snug strap should not allow any slack. It lies in a relatively straight line without sagging. It does not press on the child's flesh or push the child's body into an unnatural position.

- **NEVER** use clothing or blankets that interfere with fastening or tightening the harness. An unsecured child could be ejected in a sudden stop or crash!

To keep child warm, place a blanket over child and restraint **AFTER** you have properly secured child in harness.

- **ALWAYS** check to make sure buckle is securely latched. If buckle separates, child could be killed or seriously injured.
- **NEVER** leave child unattended. Do not allow children to play in or around the Child Restraint.

IMPORTANT WARNINGS



Install Child Restraint Correctly

- **WHEN USING THIS CHILD RESTRAINT REAR-FACING, DO NOT PLACE THIS CHILD RESTRAINT IN VEHICLE SEATING LOCATION WITH A FRONTAL AIR BAG, UNLESS THE AIR BAG CAN BE TURNED OFF.** If the airbag inflates, it can cause serious injury or death to your child. For vehicles with side air bags, refer to you vehicle owners manual for information on your child restraint installation.
- **ALWAYS** install this Child Restraint in a back seat if possible.

According to accident statistics, children are safer when properly restrained in the rear seating positions rather than in the front seat.

- **NEVER** install in rear facing, side facing or on the back of a folded down vehicle seat.
- **ALWAYS** secure this Child Restraint with the vehicle's child restraint anchorage system (LATCH) if available OR the vehicle seat belt. Refer to Page 5 for proper use/child weight limits when installing with LATCH.
- **DO NOT** use the lower anchors of the child restraint anchorage system (LATCH system) to attach this Child Restraint **REAR-FACING** when restraining a child weighing more than **35lbs (16 kg)** with the internal harness of the child restraint or **FORWARD-FACING** when restraining a child weighing more than **40lbs (18kg)** with the internal harness of the child restraint.



Install Child Restraint Correctly

- **ALWAYS** use the top tether strap on this child restraint when installed FORWARD-FACING, if a tether anchor is available.
- **NEVER** use Child Restraint in a vehicle seating position where it cannot be secured tightly. A loosely installed child restraint will not protect your child in a crash.
- **Never leave Child Restraint unsecured in your vehicle even when it is unoccupied.** It could injure other occupants in a sudden stop or crash.
- **DO NOT** install this child restraint using an inflatable seat belt. The interaction of the inflatable portion of the vehicle's belt with this child restraint **can result in serious injury or death.** Install using LATCH instead, or move the car seat to a position with a suitable seat belt type.

Ensure Child's Safety When Using Child Restraint

- **NEVER** leave your child unattended in the vehicle.
- **STRANGULATION HAZARD:** Your child can strangle in a loose Restraint Harness. Never leave a child in the Child Restraint with straps loose or undone.
- To **prevent ejection or breathing difficulties, proper recline is required.** When installing the Child Restraint, check the bubble level on the side of the child restraint.

IMPORTANT WARNINGS



Check Condition of Restraint

- **DO NOT** use if the Harness or LATCH straps are cut, frayed or damaged.
- **DO NOT use this Child Restraint if it is more than 8 years old.** Check manufacturer's label on underside of Child Restraint for the "Do Not Use After" date.
- **DO NOT use any accessories, pads or products not included with this Child Restraint, unless approved by Chicco USA.** Doing so will void the warranty of this Child Restraint.
- You **MUST** replace this Child Restraint if it has been involved in a crash, even if you cannot see visible damage. A damaged Child Restraint may not protect your child in a future crash.
- **Do not modify your Child Restraint.**
- **NEVER** remove harness from Child Restraint. For proper removal and installation of the harness straps contact Chicco USA for additional instructions.
- **Do not use Child Restraint if any component is damaged, broken, or missing parts.** Call 1-877-424-4226 to find out if the damaged part or parts can be replaced.

IMPORTANT WARNINGS

PAGE INTENTIONALLY LEFT BLANK

BEST PRACTICES

- Ensure all vehicle occupants are properly restrained before traveling. Unrestrained occupants can be thrown around and may be seriously injured or seriously injure other occupants in a sharp turn, sudden stop or crash.
- Do not leave loose objects, such as books, bags, etc., in the back of the vehicle. In the event of a sharp turn, sudden stop, or crash, loose objects can be thrown around and possibly cause serious injury to vehicle occupants.
- Cover the Child Restraint when the vehicle is parked in sunlight. Parts of a Child Restraint can become very hot if left in the sun. Contact with these parts can burn a child's skin. Always check the surface of any metal or plastic parts before putting your child in the Child Restraint.
- To avoid strangulation, Do not allow children to play with vehicle seat belts. If possible, move unused belts out of reach.
- Do not use anything to raise the Child Restraint off the vehicle seat. In a sharp turn, sudden stop, or crash, the Child Restraint could slide and potentially cause serious injury.
- Never use a second-hand Child Restraint with an unknown history.

Need Help Securing Your Child Restraint?

The following sources are available to help ensure your Child Restraint is properly installed:

- Contact Chicco, USA by visiting our website at www.chiccousa.com or calling our Customer Service 1-877-424-4226. Please have Model and Serial Number available when you call. These are located on a label on the bottom of the Child Restraint.
- Refer to your vehicle manual for Child Restraint installation tips.
- Contact a certified Child Passenger Safety Technician in your area by visiting safercar.gov and select “Find Local Child Seat Help” or call 1-866-SEAT CHECK (1-866-732-8243).

CHILD RESTRAINT COMPONENTS

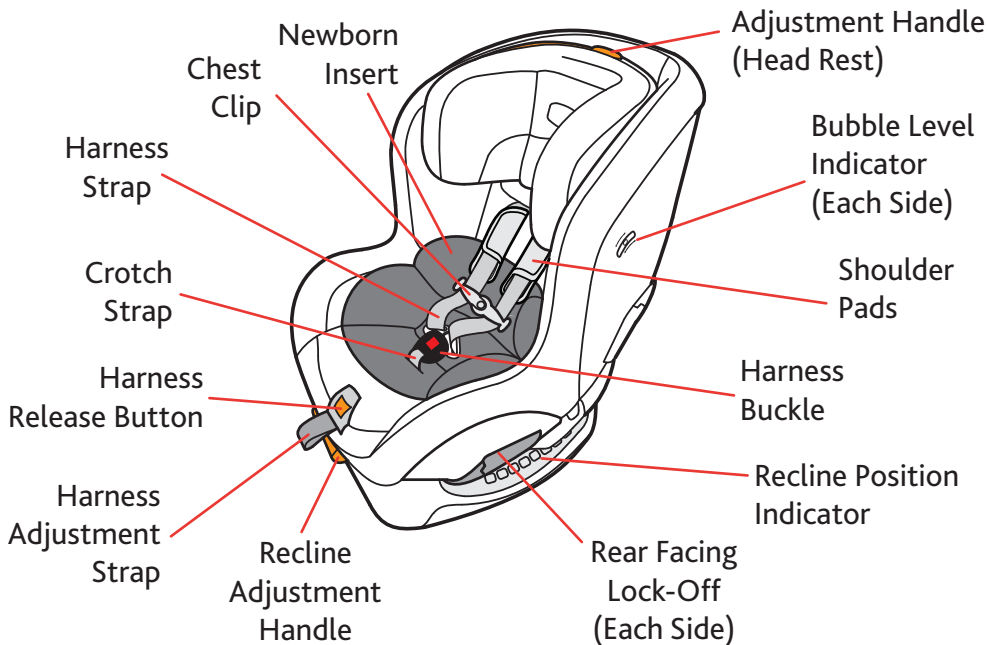

CHILD RESTRAINT COMPONENTS

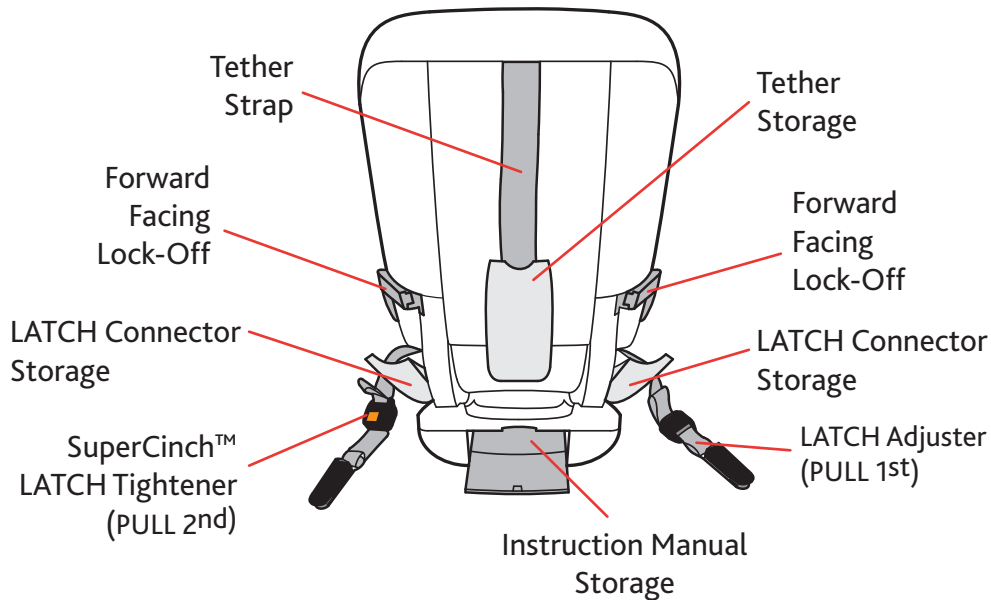

LATCH AND TETHER COMPONENTS

TETHER:

- A** Tether Strap
- B** Tether Strap Adjuster
- C** Tether Hook

LATCH:

- D** LATCH Adjuster (PULL 1st)
- E** SuperCinch LATCH Tightener (PULL 2nd)
- F** LATCH Strap
- G** LATCH Connectors

LATCH AND TETHER COMPONENTS

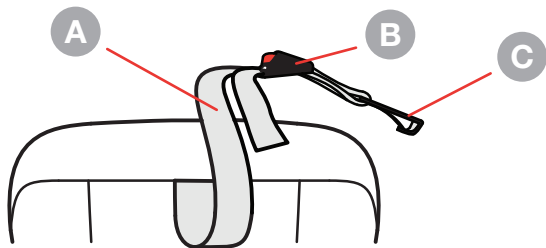

Tether

LATCH

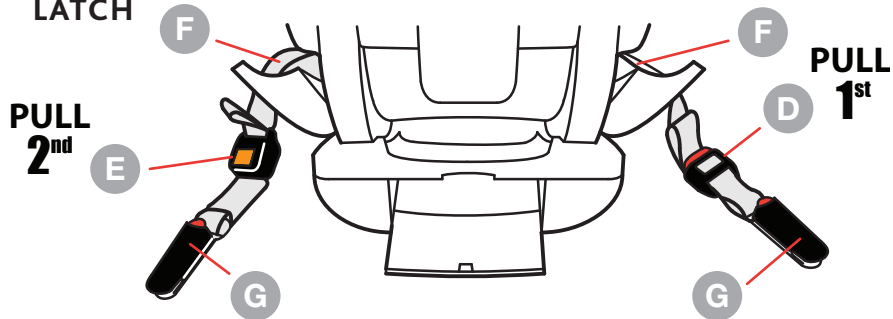

LATCH AND TETHER STORAGE

⚠ Always make sure LATCH Components are properly stored in the compartments when not in use.

LATCH STORAGE:

- 1 Store each LATCH strap in the compartments located on either side of the Child Restraint base when not in use. Make sure LATCH Connector Storage compartments are properly closed.

Fold SuperCinch™ LATCH Tightener (Pull 2nd) strap as shown (1a).

TETHER STORAGE:

Store Tether in the compartment in the back of Child Restraint when not in use. Hook on bar and pull strap tight. Make sure compartment door is properly closed.

LATCH AND TETHER STORAGE

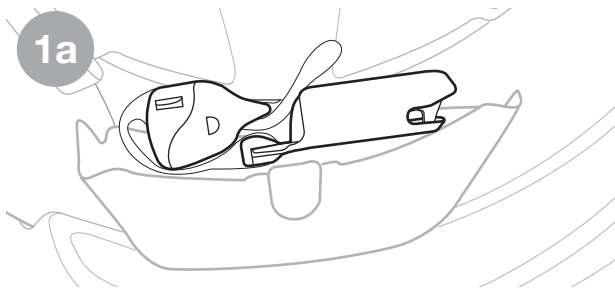
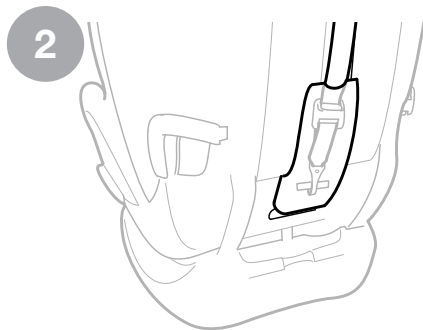
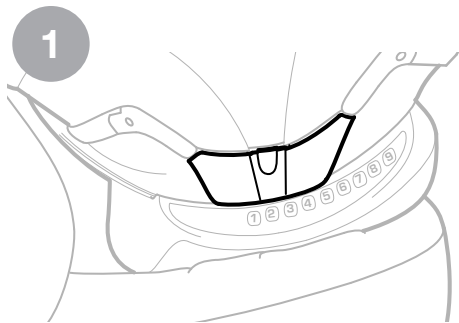

SELECT REAR FACING POSITION

▲ **WARNING! REAR-FACING** use of this Child Restraint is ONLY for children who meet ALL of the requirements shown here. If the child is not within these requirements because they are too small, select a different child seat (such as an infant car seat). If the child is not within these requirements because the child is too large, review the FORWARD-FACING guidelines on page 24.

- Chicco and the American Academy of Pediatrics recommend all children ride REAR-FACING until age 2 or they reach the weight/height limits of this seat.
- NEVER turn this Child Restraint FORWARD-FACING with an infant less than one year of age.

SELECT REAR FACING POSITION

REAR-FACING:

5 – 40 lbs (2.2 – 18 kg)

Use **REAR-FACING** with children:

- Who weigh between 5 and 40 lbs (2.2 – 18 kg).
- When Harness Straps can be positioned at or below the child's shoulders*.

See Harness Height Adjustment on page 80.

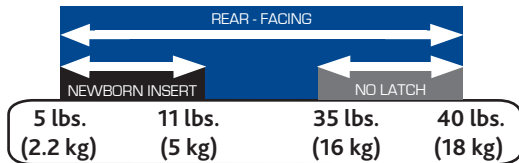

SELECT FORWARD FACING POSITION

⚠ **WARNING! FORWARD-FACING** use of this Child Restraint is ONLY for children who meet ALL of the requirements shown here. If the child is not within these requirements because they are too large, select a different child seat. If the child is not within these requirements because the child is too small, review the REAR-FACING guidelines on page 22.

- Chicco and the American Academy of Pediatrics recommend that children ride REAR FACING for as long as possible. For the best protection, keep the child rear-facing until the child no longer meets the requirements for REAR-FACING.

SELECT FORWARD FACING POSITION

FORWARD-FACING:

22 – 65 lbs (10 – 29.4 kg)

Use **FORWARD-FACING** with children:

- Who are at least one year old.
- Who weigh between 22 and 65 lbs (10 –29.4 kg).
- Who are 49" (1245 mm) tall or less **OR** when the top of the ears are below the top of the Head Rest.
- When Harness Straps can be positioned at or above the child's shoulders*.

See Harness Height Adjustment on page 80.

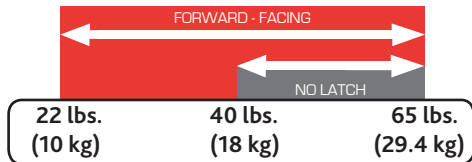

ADJUSTING CROTCH STRAP

Adjust Crotch Strap if strap is underneath child.

- 1 Lift up on the back padding.
- 2 Unsnap each side of the back padding and pull forward on the seat padding.
- 3 Slide the button on the Crotch Strap lock while pulling up on the Crotch Strap to open the compartment (a, b).
- 4 Pull the Crotch Strap forward or backward into desired position.
- 5 Close the compartment by pushing down on the door until it locks back into place. Check to make sure compartment is locked by pulling up on the Crotch Strap. Re-attach the padding.

ADJUSTING CROTCH STRAP

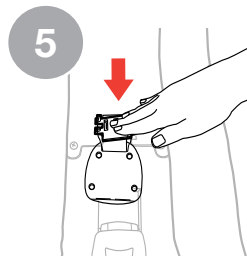
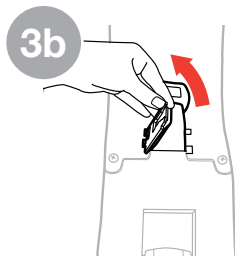
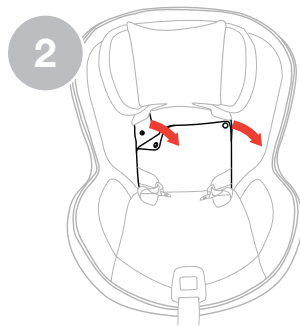
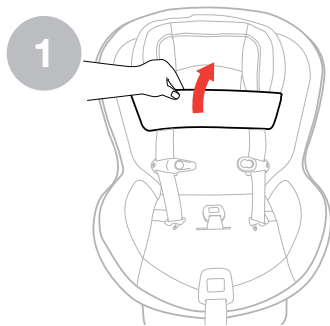

NEWBORN INSERT

⚠ WARNING - ONLY use the insert if the child's weighs between 5 and 11 lbs (2.2 and 5 kg).

To ensure a better fit for smaller infants the Newborn Insert may be needed. Do NOT use any other infant insert or pillows. Only use the one provided by Chicco for this Child Restraint.

- 1 Pull Harness Buckle through slot in the bottom of Newborn Insert.
- 2 Pull both Harness Straps over the side panels of Newborn Insert.
- 3 Push Newborn Insert firmly into Child Restraint(a) to make sure it is properly positioned (b).

NEWBORN INSERT

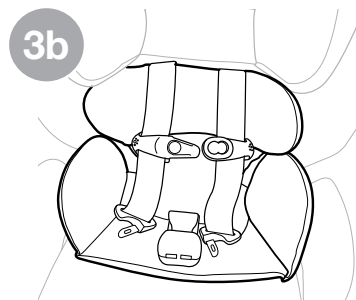
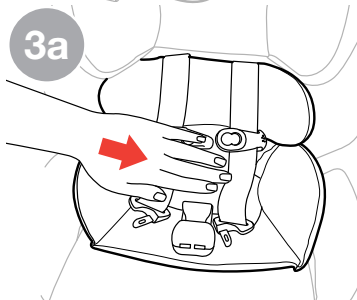
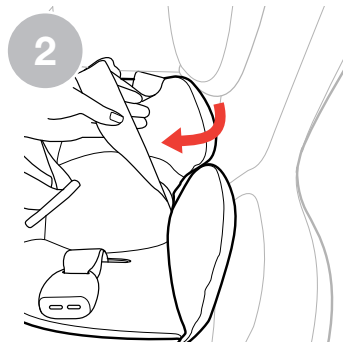
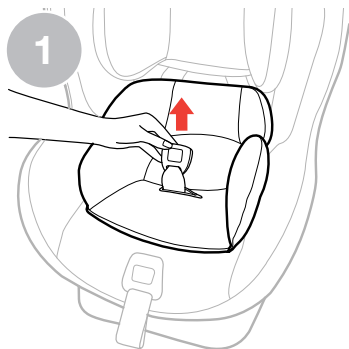

VEHICLE SEATING POSITIONS



⚠ WARNING! WHEN USING THIS CHILD RESTRAINT REAR-FACING, DO NOT PLACE THIS CHILD RESTRAINT IN A VEHICLE SEATING LOCATION WITH A FRONTAL AIR BAG, UNLESS THE AIR BAG CAN BE TURNED OFF.

The back seat is the safest place for children 12 and under. See your vehicle owner's manual for Child Restraint installation and instructions.

VEHICLE SEATING POSITIONS

Some vehicles have no seating positions which are compatible with this Child Restraint. If in doubt, contact the vehicle manufacturer for assistance. Only forward-facing vehicle seats can be used with this Child Restraint.



Make sure no more than 3 inches of the Child Restraint base is past the edge of the vehicle seat.



Do not use on a folded down vehicle seat back.

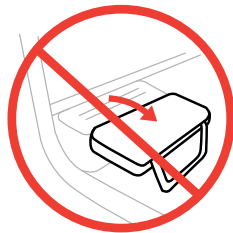

VEHICLE SEAT BELTS

The information in this section only applies to installation with vehicle seat belts.

For simplest installation use LATCH - Refer to page 34 for details.

Vehicle seat belts differ from vehicle to vehicle. Refer to your vehicle owner's manual for specific information about seat belts and their use with Child Restraints.

Shoulder belt with switchable retractor:

Putting the shoulder belt in the locked/switched mode as the last step is optional. The shoulder belt Lock-Off replaces the need for the locked/switched mode. When the Child Restraint is rear-facing using the locked/switched mode may cause Child Restraint to tilt.

VEHICLE SEAT BELTS

The following types of vehicle belts **MUST NOT** be used to install this Child Restraint. If any of the belt types listed below are in the chosen seating position, choose another vehicle seating position or use LATCH if available.

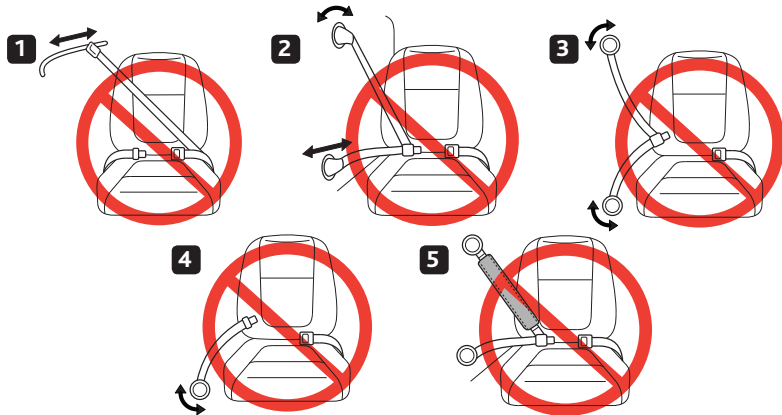

1. Motorized (automatic) vehicle belts.
2. Door mounted vehicle belts.
3. Lap-shoulder Belts with 2 retractors (unless Lap Belt has a "Lock Mode").
4. Non-Locking (ELR) Lap Belts.
5. Inflatable seat belts.

WHAT IS LATCH?

⚠ WARNING: This Child Restraint is designed to be used with lower LATCH anchors at the standard spacing (11 inches) **ONLY!** Refer to vehicle owner's manual for information about LATCH and Child Restraint installation positions.

LATCH = Lower Anchors and Tethers for Children

United States Motor Vehicle Safety Standards have defined a system for installing Child Restraints in vehicles called LATCH. **LATCH may ONLY be used IN PLACE OF vehicle belt if the vehicle is equipped with LATCH anchor points. DO NOT use both the seat belt and LATCH at the same time. Please refer to the vehicle owner's manual for designated LATCH locations in vehicles.**

LATCH in the vehicle consists of a top tether anchor point and two lower anchor points. Some vehicles owner's manual use the term "**ISOFIX**". **LATCH** can also be used in vehicle seating positions equipped with **ISOFIX**.

If the vehicle is equipped with **LATCH**, the vehicle lower anchor points may be visible at the seat crease. If not visible, the seating position may be marked with a symbol (fig. a) or a colored dot. Check the vehicle owner's manual for vehicle top tether anchor locations. They may be identified using one of the anchor symbols (fig. b or fig. c).

WHAT IS LATCH?

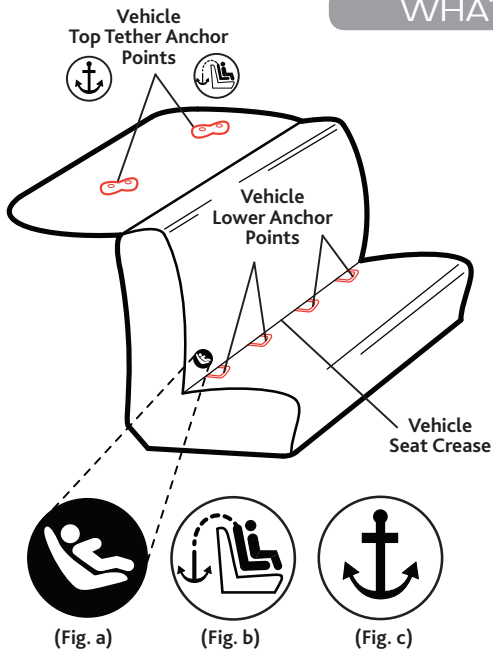

WHAT IS A TETHER?



Tether anchor locations vary from vehicle to vehicle. Check your vehicle owner's manual and look for the tether anchor symbol as shown. A tether reduces movement of a forward facing child restraint in a crash and helps to achieve a tight installation.

Vehicle tether anchors can be found in many different locations. Some of the typical locations are shown here. Refer to your vehicle owner's manual for exact locations, anchor identification, and requirements.

WHAT IS A TETHER?

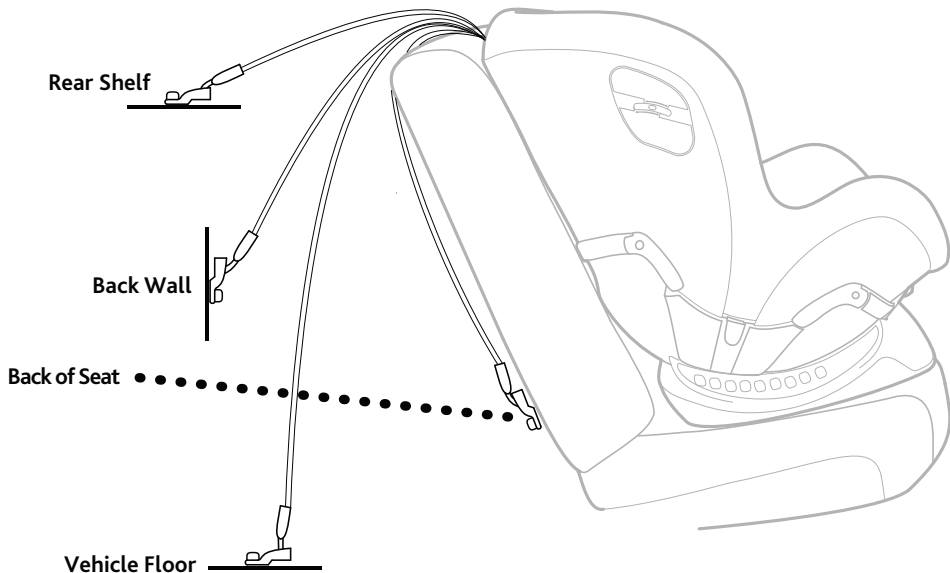

REAR-FACING SETUP

⚠ Infants may have difficulty breathing when in a sitting position. Make sure the seat is reclined properly so that your child's head does not fall forward. **Failure to properly recline the Child Restraint could increase the child's risk of serious injury or death.**

- 1 Make sure the vehicle is on a level surface, if possible.



- 2 Squeeze the Recline Adjustment Handle on front of Child Restraint and pull forward to adjust to a reclined position as shown (a).

Do not use Tether in REAR-FACING mode. Tether must be properly stored - See "Tether Storage" page 20.

REAR-FACING SETUP

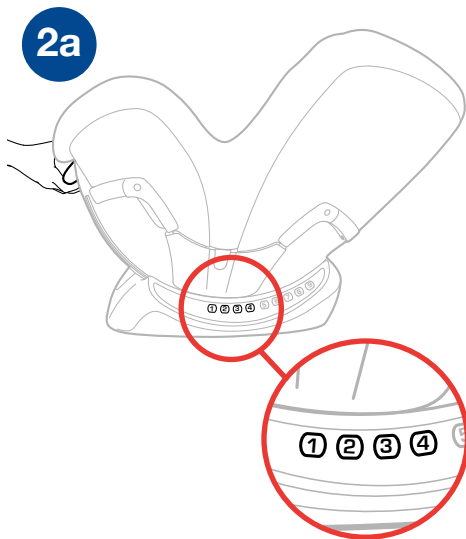
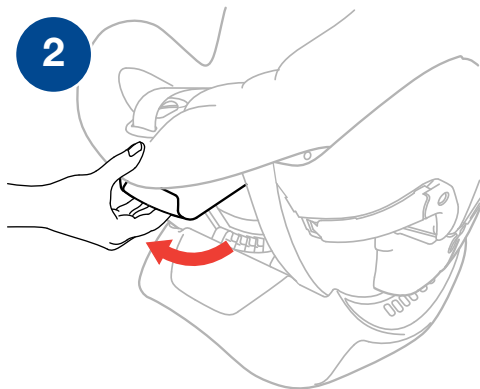

REAR-FACING SETUP

- 3 Place Child Restraint rear-facing on selected vehicle seat. Make sure it is not blocking the vehicle belt buckle.

4



Installation on a Level Surface: Locate the Bubble Level Indicator label and re-adjust the seat recline to any position that the Bubble falls between the lines for **REAR-FACING** installation.



Installation on a Slope: Locate the level line on the blue label near the rear-facing belt path. Adjust the seat recline so that the level line is level with the ground.

Installation Options:

- *LATCH installation continued on page 42.*
- *Lap-Shoulder Belt installation continued on page 46.*
- *Lap Belt Only installation continued on page 52.*

REAR-FACING SETUP

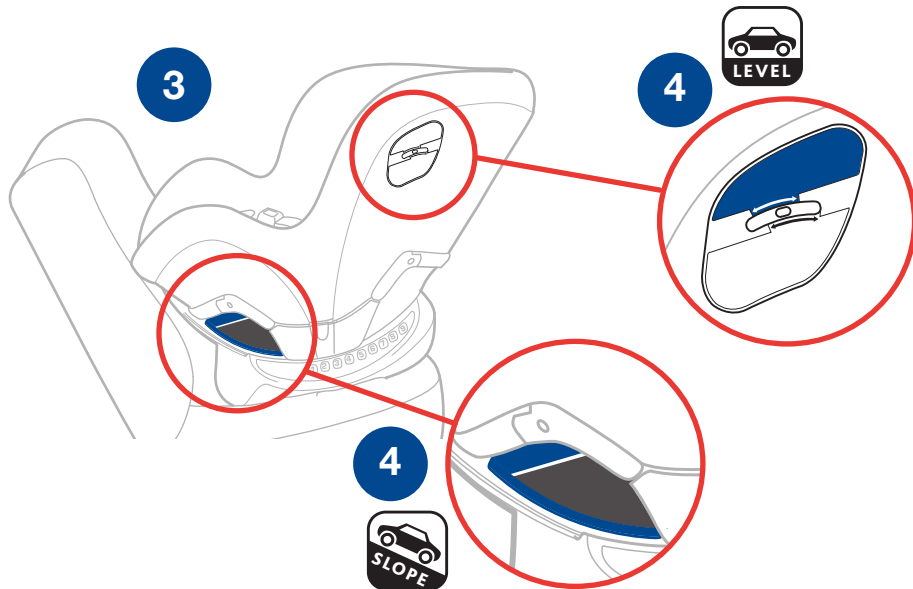

INSTALL USING LATCH

⚠ Do not use the lower anchors of the child restraint anchorage system (LATCH system) to attach this Child Restraint when restraining a child weighing more than **35lbs (16 kg)** with the internal harness of the child restraint.

⚠ When installing with LATCH, the unused seat belt should not be buckled behind the Child Restraint System as this will engage the inflatable portion of the belt.

- 1 Locate the LATCH Connector Storage compartments. Remove LATCH straps. Make sure SuperCinch™ LATCH Tightener strap (Pull 2nd) and LATCH Adjuster strap (Pull 1st) are loosened to their full length.
- 2 Grab both ends of LATCH straps. Slide LATCH strap to blue REAR-FACING opening on both sides. Note: Both LATCH Connector Storage compartments must be open and both LATCH straps must be loosened to their full length in order to slide LATCH straps into position.
- 3 Close both LATCH Connector Storage compartments.

INSTALL USING LATCH

Make sure LATCH Adjuster strap (Pull 1st) is loosened to the full length.

1

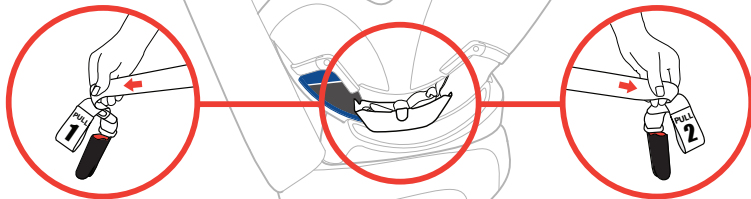

Make sure SuperCinch™ LATCH Tightener strap (Pull 2nd) is loosened to the full length.

2

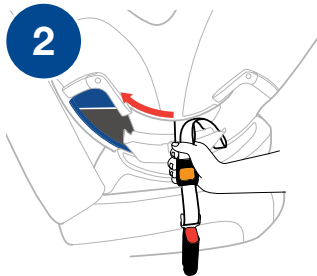

3

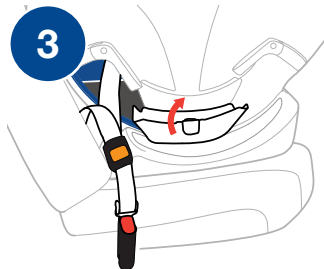

INSTALL USING LATCH

⚠ When not accessing the LATCH or changing the belt path **ALWAYS** keep LATCH Connector Storage compartments closed.

- 4 Locate the LATCH anchor bars in your vehicle. Attach both LATCH Connectors to the vehicle LATCH anchor bars.
- 5 Pull up on the end of the LATCH Adjuster strap (Pull 1st) until strap is tight.
- 6 Pull on the SuperCinch™ LATCH Tightener strap (Pull 2nd) to secure the Child Restraint.

CHECK YOUR WORK

- ✓ Hold Child Restraint at each side near REAR-FACING vehicle belt paths. Pull side to side and forward. Child Restraint should not move more than 1" (25 mm) from vehicle seat back or side-to-side.
- ✓ Make sure Child Restraint is level for REAR-FACING use. Make sure infant's head does not fall forward. If necessary, loosen the Latch Strap, re-adjust recline and repeat installation steps to make sure Child Restraint is installed properly.
- ✓ Check installation before every use!

INSTALL USING LATCH

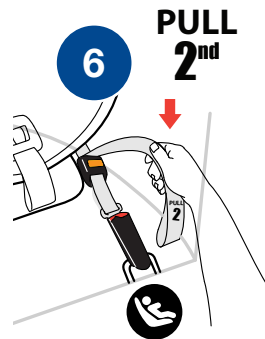
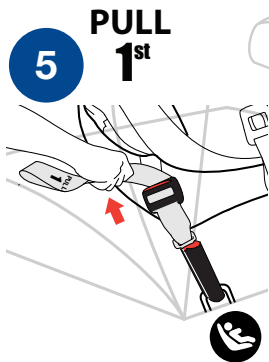
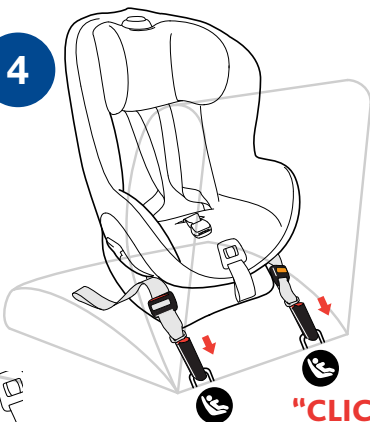

INSTALL USING LAP-SHOULDER BELT

- 1 Always use the Lock-Off on the opposite side of the vehicle belt buckle. Lift up on Lock-Off Lever to open it.
- 2 Route vehicle lap-shoulder belt through the blue **REAR-FACING** seat belt path on the side of Child Restraint.
- 3 Pull vehicle belt up through the opening in Child Restraint base. Route the vehicle belt **UNDER** the seat padding and behind the Crotch Strap, when Crotch Strap is located in forward position.
- 4 Pull vehicle belt down through the blue **REAR-FACING** seat belt path on opposite side of Child Restraint. Buckle the vehicle belt.

INSTALL USING LAP-SHOULDER BELT

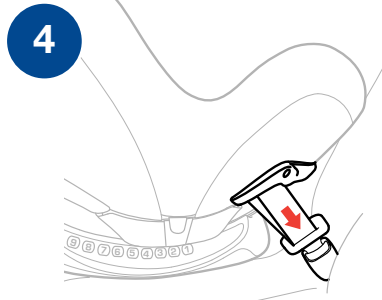
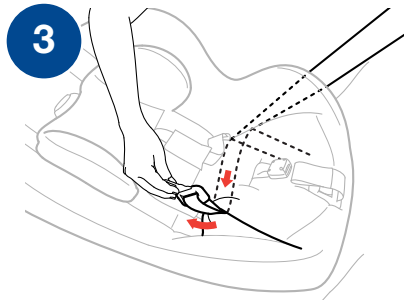
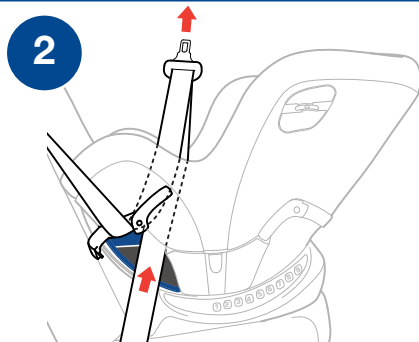
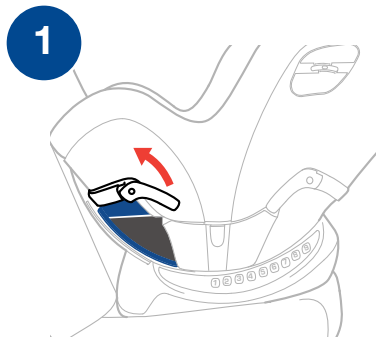

INSTALL USING LAP-SHOULDER BELT

- 5 While pushing down on the Child Restraint (a) pull the vehicle shoulder belt (b) to tighten vehicle lap belt.
- 6 Continue to pull on the vehicle shoulder belt and position the shoulder belt in the middle of the Lock-Off area between the tabs. Lock-Off will not close and lock in place if the vehicle belt is not positioned correctly.
- 7 While still pulling the shoulder belt tight, close the Lock-Off Door (a) and push down on the lever to lock the Lock-Off and belt (b).

⚠ Keep Lock-Off closed at all times.

⚠ Do NOT pull on shoulder belt after the Lock-Off is closed. This could damage the Lock-Off and/or the vehicle belt.

INSTALL USING LAP-SHOULDER BELT

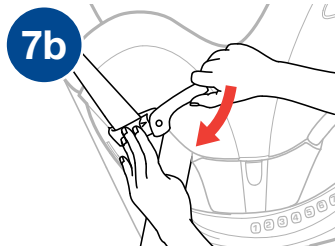
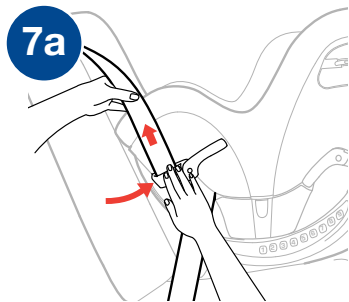
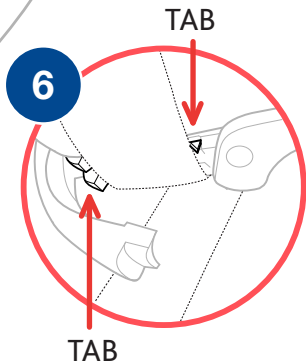
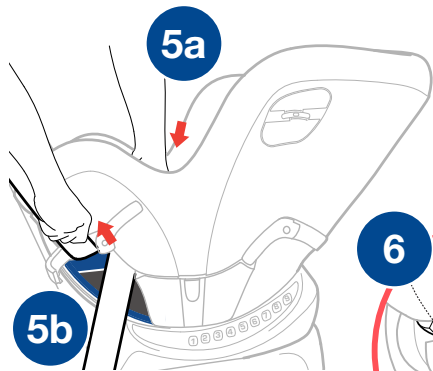

INSTALL USING LAP-SHOULDER BELT

CHECK YOUR WORK

- ✓ Hold Child Restraint at each side near REAR-FACING vehicle belt paths. Pull side to side and forward. Vehicle belt should remain tight and Child Restraint should not move more than 1" (25 mm) from vehicle seat back or side-to-side.
- ✓ Make sure Child Restraint is level for REAR-FACING use. Make sure infant's head does not fall forward. If necessary, loosen the vehicle belt, re-adjust recline and repeat installation steps to make sure Child Restraint is installed properly.
- ✓ Check installation before every use!

PAGE INTENTIONALLY LEFT BLANK

INSTALL USING LAP BELT ONLY

- 1 Route vehicle lap belt through the blue **REAR-FACING** seat belt path on the side of Child Restraint.
- 2 Pull vehicle belt up through the opening in Child Restraint base. Route the vehicle belt **UNDER** the seat padding and behind the Crotch Strap when Crotch Strap is located in forward position.
- 3 Pull vehicle belt down through the blue **REAR-FACING** seat belt path on opposite side of Child Restraint. Buckle the vehicle belt.

INSTALL USING LAP BELT ONLY

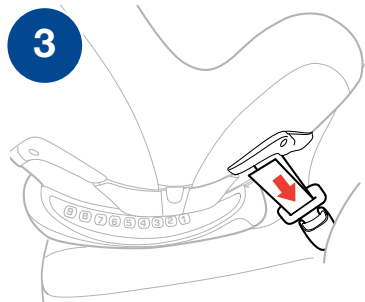
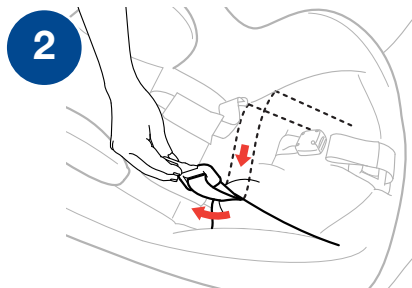
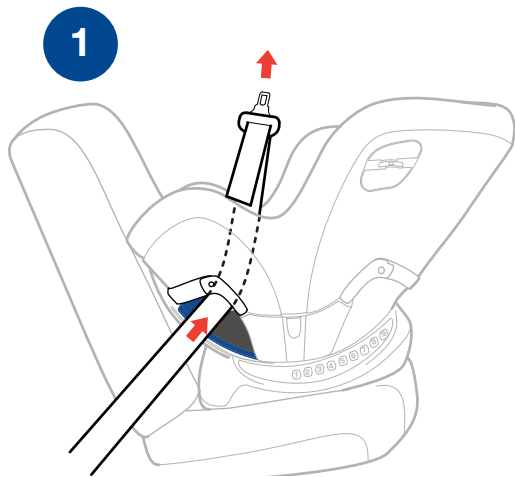

INSTALL USING LAP BELT ONLY

- 4 While pushing down on the Child Restraint (a) pull the loose end of the vehicle lap belt (b) to tighten belt.

CHECK YOUR WORK

- ✓ Hold Child Restraint at each side near REAR-FACING vehicle belt paths. Pull side to side and forward. Vehicle belt should remain tight and Child Restraint should not move more than 1" (25 mm) from vehicle seat back or side-to-side.
- ✓ Make sure Child Restraint is level for REAR-FACING use. Make sure infant's head does not fall forward. If necessary, loosen the vehicle belt, re-adjust recline and repeat installation steps to make sure Child Restraint is installed properly.
- ✓ Check installation before every use!

INSTALL USING LAP BELT ONLY

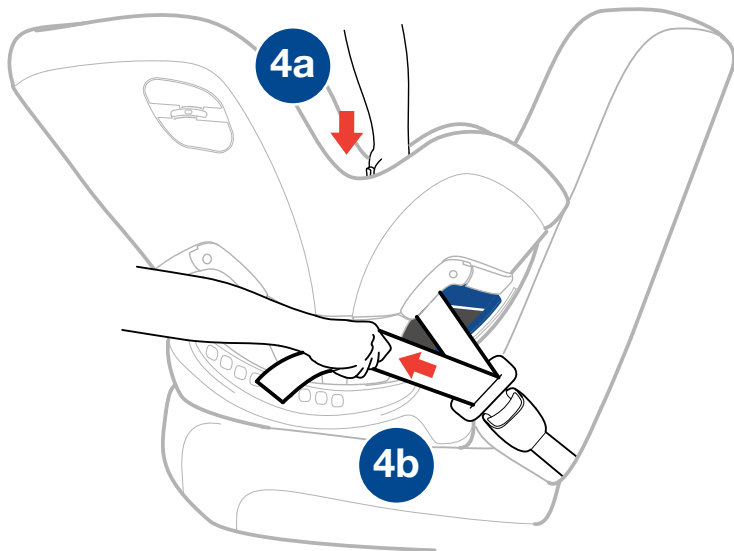

FORWARD-FACING SETUP

- 1 IF TETHER ANCHOR IS AVAILABLE IN YOUR VEHICLE - Before placing the Child Restraint in the vehicle, remove Tether from the tether compartment. If a tether anchor is not available, the Tether should be stored properly.

- 2 Make sure the vehicle is on a level surface, if possible.



- 3 Squeeze the Recline Adjustment Handle on front of Child Restraint and push back to adjust to an upright position as shown (a).

FORWARD-FACING SETUP

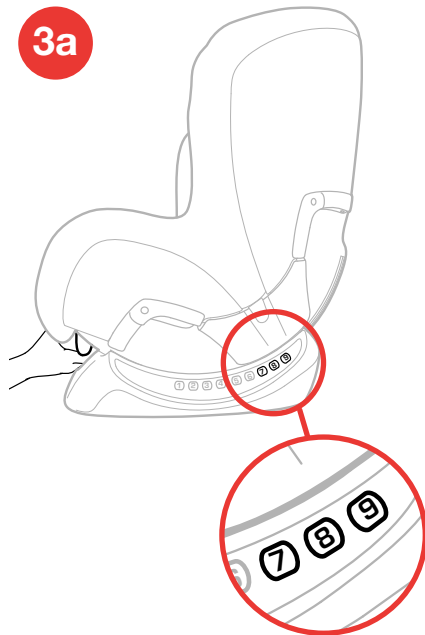
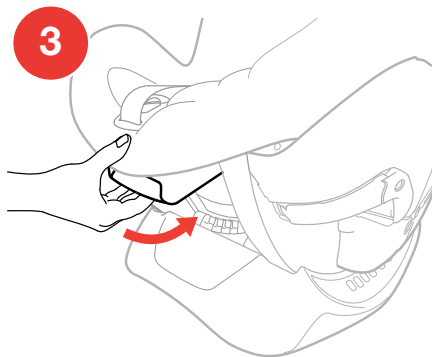
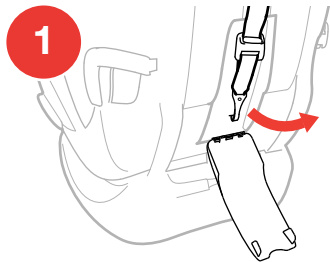

FORWARD-FACING SETUP

4 Place Child Restraint facing forward on selected vehicle seat. Make sure it is not blocking the vehicle belt buckle. Lay Tether Strap over the back of the vehicle seat.



5 **Installation on a Level Surface:** Locate the Bubble Level Indicator label and re-adjust the seat recline to any position that the Bubble falls between the lines for **FORWARD-FACING** installation.



Installation on a Slope: If vehicle is on a slope adjust the seat recline to position 8 or 9 ONLY.

Installation Options:

- *LATCH installation continued on page 60.*
- *Lap-Shoulder Belt installation continued on page 66.*
- *Lap Belt Only installation continued on page 72.*

FORWARD-FACING SETUP

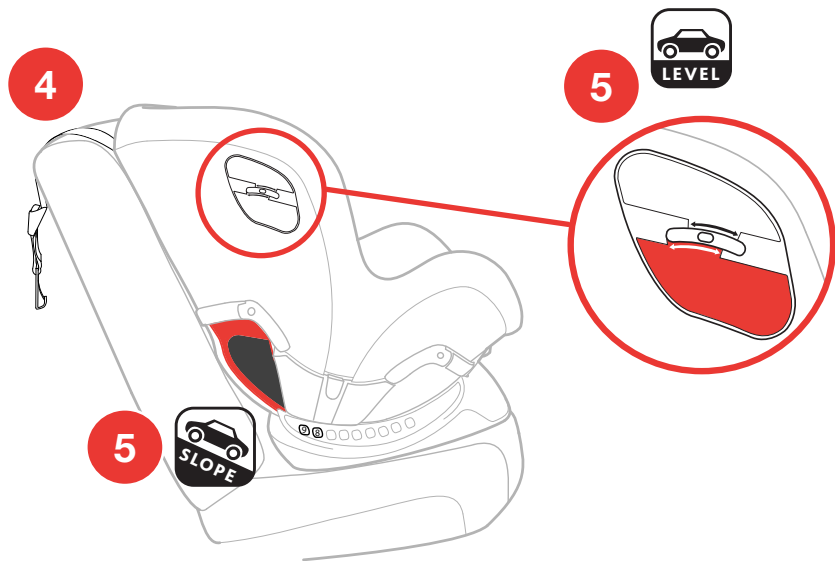

INSTALL USING LATCH

⚠ Do not use the lower anchors of the child restraint anchorage system (LATCH system) to attach this Child Restraint when restraining a child weighing more than **40lbs (18 kg)** with the internal harness of the child restraint.

⚠ When installing with LATCH, the unused seat belt should not be buckled behind the Child Restraint System as this will engage the inflatable portion of the belt.

- 1 Locate LATCH Connector Storage compartments. Remove LATCH straps. Make sure SuperCinch™ LATCH Tightener strap (Pull 2nd) and LATCH Adjuster strap (Pull 1st) are loosened to their full length.
- 2 Grab both ends of LATCH straps. Slide LATCH strap to red **FORWARD-FACING** opening on both sides. Note: Both LATCH Connector Storage compartments must be open and both LATCH straps must be loosened to their full length in order to slide LATCH straps into position.
- 3 Close both LATCH Connector Storage compartments.

INSTALL USING LATCH

Make sure SuperCinch™ LATCH Tightener strap (Pull 2nd) is loosened to the full length.

1

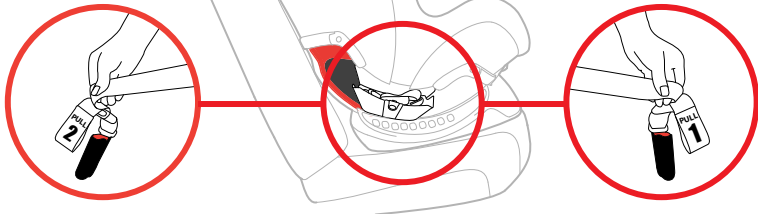

Make sure LATCH Adjuster strap (Pull 1st) is loosened to the full length.

2

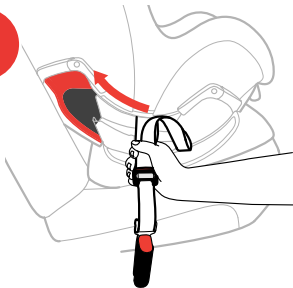

3

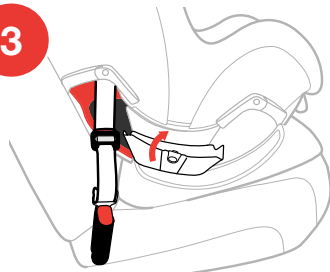

INSTALL USING LATCH

⚠ When not accessing the LATCH or changing the belt path **ALWAYS** keep LATCH Connector Storage compartments closed.

- 4 Locate the LATCH anchor bars in your vehicle. Attach both LATCH Connectors to the vehicle LATCH anchor bars.
- 5 Pull up on the end of the LATCH Adjuster strap (Pull 1st) until strap is tight.
- 6 Pull on the SuperCinch™ LATCH Tightener strap (Pull 2nd) to secure Child Restraint.

INSTALL USING LATCH

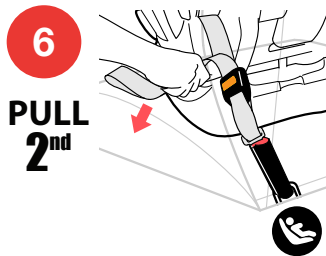
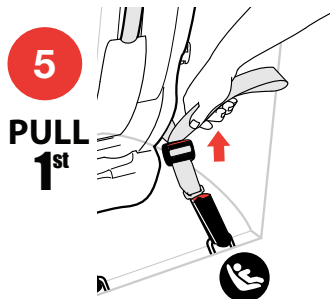
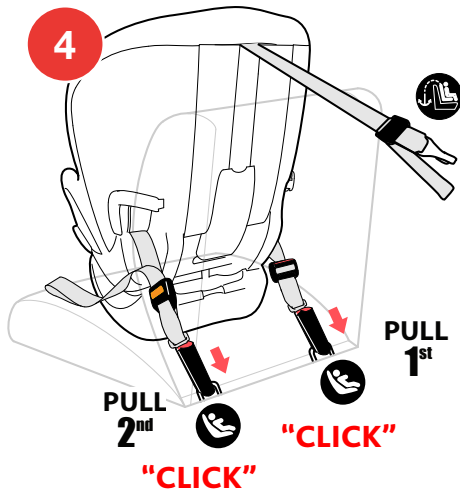

INSTALL USING LATCH

- 7 Locate Tether anchor in your vehicle. Attach Tether Hook. Pull Tether Adjuster strap to tighten.

CHECK YOUR WORK

- ✓ Hold Child Restraint at each side near forward-facing vehicle belt path. Pull side to side and forward. Child Restraint should not move more than 1" (25 mm) from vehicle seat back or side-to-side.
- ✓ Make sure Bubble is between lines on label for FORWARD-FACING use. If necessary, loosen the LATCH and Tether Straps, re-adjust recline and repeat installation steps to make sure Child Restraint is installed properly.
- ✓ Check installation before every use!

INSTALL USING LATCH

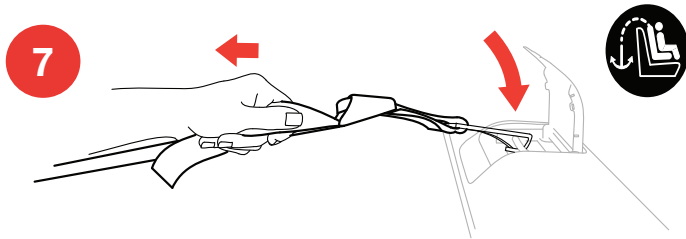

INSTALL USING LAP-SHOULDER BELT

- 1 Always use the Lock-Off on the opposite side of the vehicle belt buckle. Lift-Up on Lock-Off Lever to open it.
- 2 Route vehicle lap-shoulder belt through the red **FORWARD-FACING** seat belt path on the side of Child Restraint. Lift the padding on the back of the seat and pull the vehicle belt through the opening on the side of Child Restraint.
- 3 Pass the vehicle belt along the back of the Child Restraint as shown.
- 4 Pull the vehicle belt down through the red **FORWARD-FACING** seat belt path on the opposite side of Child Restraint. Buckle the vehicle belt. Replace the seat back padding.

INSTALL USING LAP-SHOULDER BELT

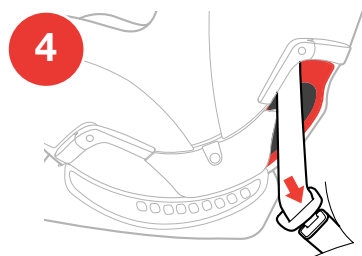
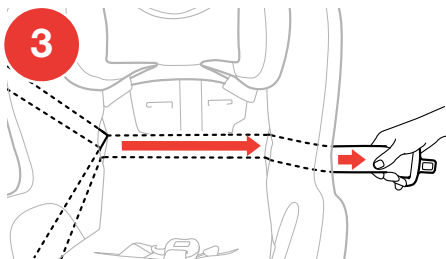
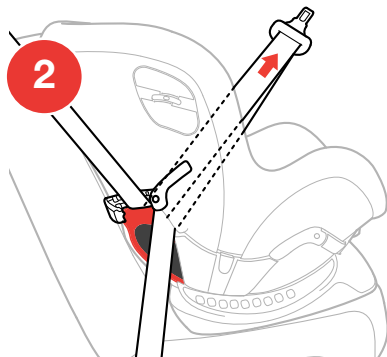
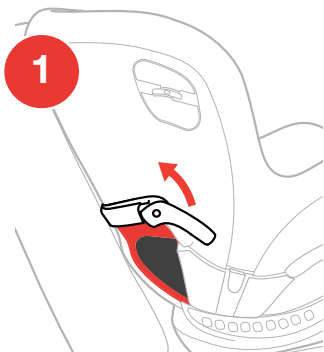

INSTALL USING LAP-SHOULDER BELT

- 5 While pushing down on the Child Restraint (a) pull the vehicle shoulder belt (b) to tighten vehicle lap belt.
- 6 Continue to pull on the vehicle shoulder belt and position the shoulder belt in the middle of Lock-Off area between tabs. Lock-Off will not close and lock in place if the vehicle belt is not positioned correctly.
- 7 While still pulling the shoulder belt tight, close Lock-Off Door (a) and push down on the lever to lock the Lock-Off and belt (b).

⚠ Keep Lock-Off closed at all times.

⚠ Do NOT pull on shoulder belt after the Lock-Off is closed.
This could damage the Lock-Off and/or the vehicle belt.

INSTALL USING LAP-SHOULDER BELT

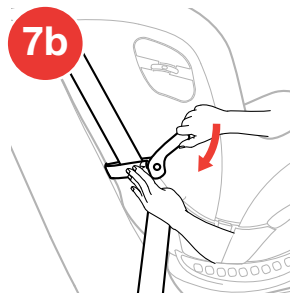
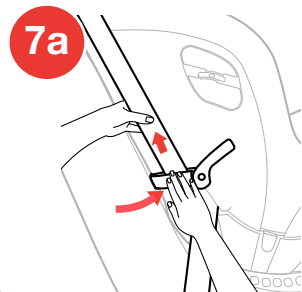
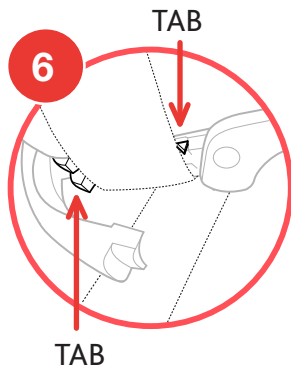
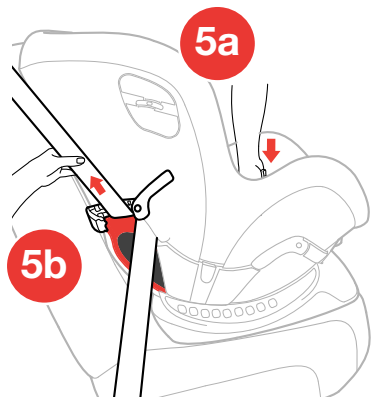

INSTALL USING LAP-SHOULDER BELT

- 8 Locate Tether anchor in your vehicle. Attach Tether Hook. Pull Tether Adjuster strap to tighten.

CHECK YOUR WORK

- ✓ Hold Child Restraint at each side near FORWARD-FACING vehicle belt path. Pull side to side and forward. Vehicle belt should remain tight and Child Restraint should not move more than 1" (25 mm) from vehicle seat back or side-to-side.
- ✓ Make sure Bubble is between lines on label for FORWARD-FACING use. If necessary, loosen the vehicle belt and Tether, re-adjust recline and repeat installation steps to make sure Child Restraint is installed properly.
- ✓ Check installation before every use!

INSTALL USING LAP-SHOULDER BELT

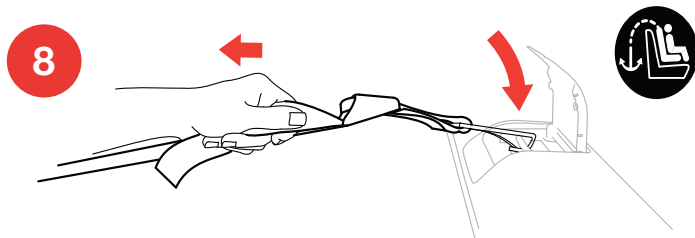

INSTALL USING LAP BELT ONLY

- 1 Route vehicle lap belt through the red **FORWARD-FACING** seat belt path on the side of Child Restraint. Lift the padding on the back of the seat and pull the vehicle belt through the opening on the side of the Child Restraint.
- 2 Pass the vehicle belt along the back of the Child Restraint as shown.
- 3 Pull the vehicle belt down through the red **FORWARD-FACING** seat belt path on the opposite side of Child Restraint. Buckle the vehicle belt. Replace the seat back padding.

INSTALL USING LAP BELT ONLY

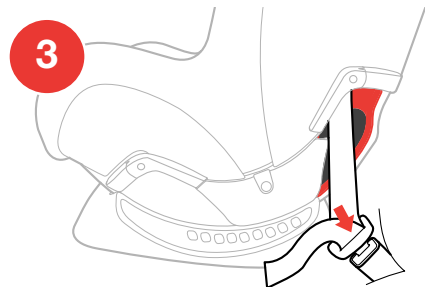
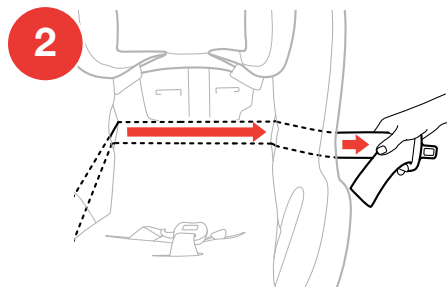
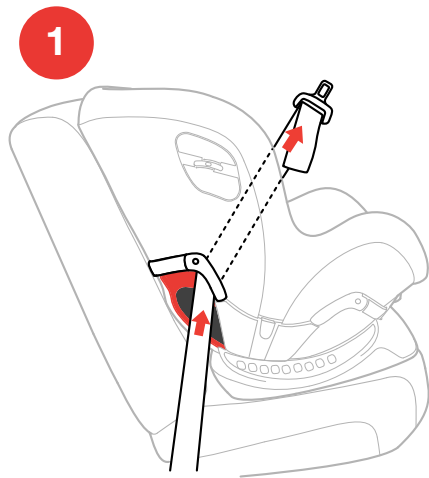

INSTALL USING LAP BELT ONLY

- 4 While pushing down on the Child Restraint (a) pull the loose end of the vehicle lap belt (b) to tighten.
- 5 Locate Tether anchor in your vehicle. Attach Tether Hook. Pull Tether Adjuster strap to tighten.

CHECK YOUR WORK

- ✓ Hold Child Restraint at each side near FORWARD-FACING vehicle belt path. Pull side to side and forward. Vehicle belt should remain tight and Child Restraint should not move more than 1" (25 mm) from vehicle seat back or side-to-side.
- ✓ Make sure Bubble is between lines on label for FORWARD-FACING use. If necessary, loosen the vehicle belt and Tether, re-adjust recline and repeat installation steps to make sure Child Restraint is installed properly.
- ✓ Check installation before every use!

INSTALL USING LAP BELT ONLY

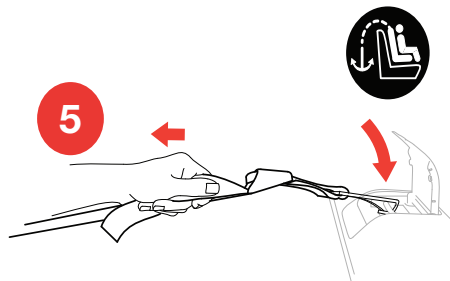
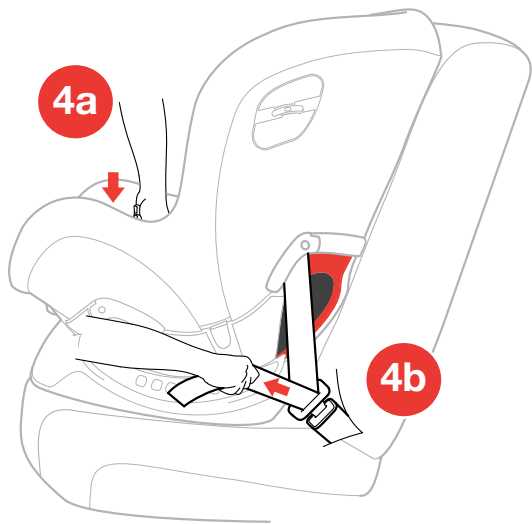

SECURING CHILD WITH HARNESS

For a better fit in the Child Restraint with smaller infants, the Newborn Insert provided may be needed. See page 28 for more details.

If Crotch Strap is under child, the crotch strap will need to be re-positioned, refer to page 26 "Adjusting Crotch Strap".

- 1** Loosen Harness by pressing Harness Release Button on the front of the Child Restraint and pulling forward on both of the Harness Straps.
- 2** Unbuckle Harness by pressing the button on Harness Buckle and pulling out both Buckle Tongues.
- 3** Open Chest Clip by pressing the button in the middle of the clip and pulling apart.

SECURING CHILD WITH HARNESS

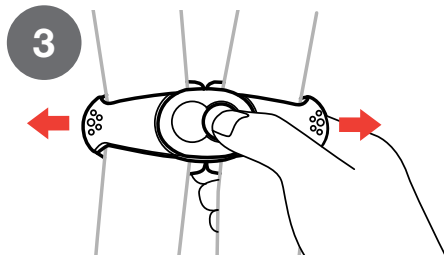
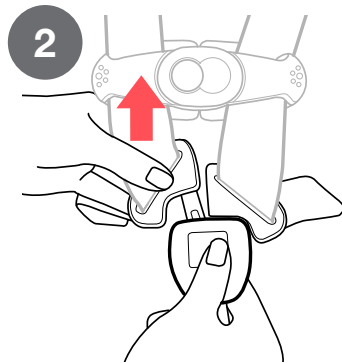
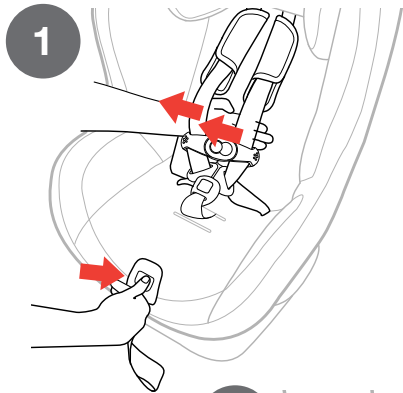

SECURING CHILD WITH HARNESS

- 4 Place child in Child Restraint with child's back flat against the back of the seat. Pull Harness Straps over the child's shoulders and around the child's waist. Make sure there are no twists in Harness Strap.

If the child is wearing cold weather clothing, give extra attention to adjusting the Harness - make sure the Harness Straps lie flat on the child's shoulders, are adjusted snugly so that the clothing is compressed and the child cannot lean forward, and the Chest Clip is at armpit level. Clothing that interferes with the proper placement or adjustment of the Harness system should never be used.

SECURING CHILD WITH HARNESS

4

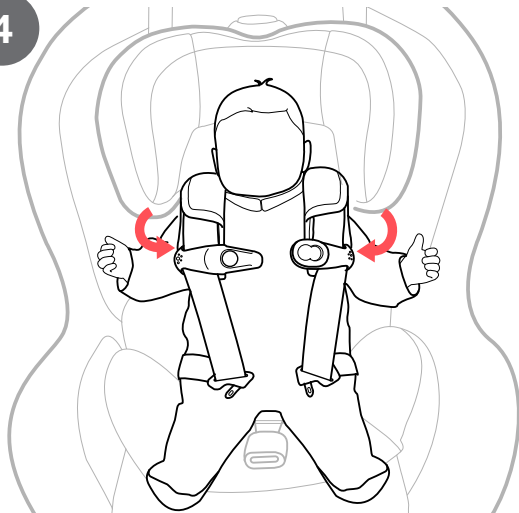

SECURING CHILD WITH HARNESS

- 5 Adjust Harness Strap height position up or down by squeezing Adjustment Handle on top of Head Rest. Make sure Head Rest locks into position before tightening Harness.

REAR-FACING POSITION - Position the Harness Straps at or below the child's shoulders.

FORWARD-FACING POSITION - Position the Harness Straps at or above the child's shoulders.

If using lowest Head Rest/Harness Position, make sure the seat back padding panel is folded under.

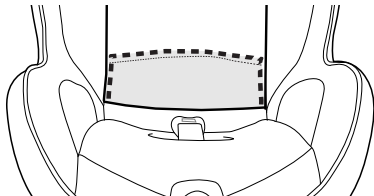

SECURING CHILD WITH HARNESS

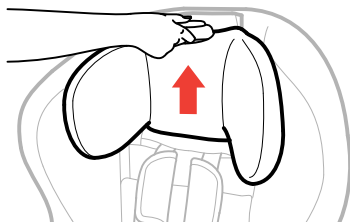
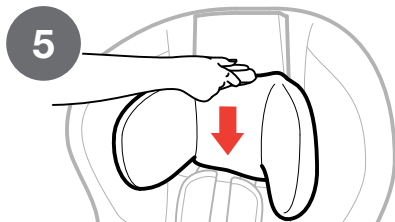

**REAR-FACING
AT OR BELOW**

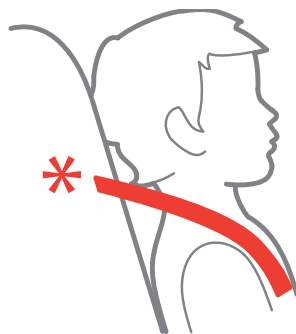

**FORWARD-FACING
AT OR ABOVE**

SECURING CHILD WITH HARNESS

- 6 Insert each Buckle Tongue into Harness Buckle; listen for a click (a). Pull up firmly on both Buckle Tongues to make sure that they are securely latched (b).

SECURING CHILD WITH HARNESS

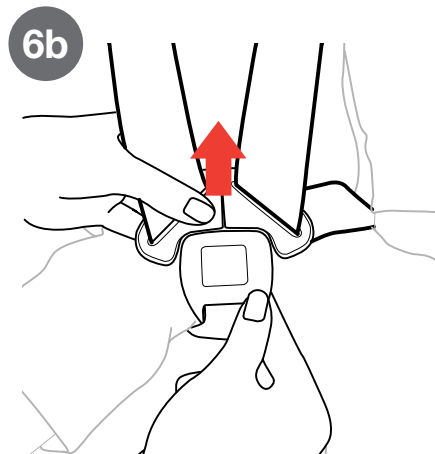
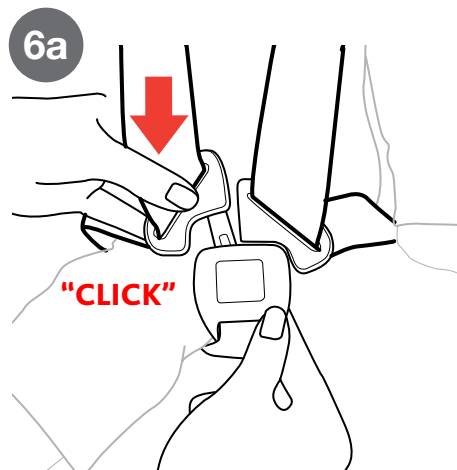

SECURING CHILD WITH HARNESS

- 7 Fasten Chest Clip by snapping both sides together; listen for a click. Press the button on the Chest Clip and slide into desired position.

Harness straps must fit snugly and lay flat on the center of your child's shoulders. The chest clip can be used in either position. Choose the position that provides the best fit for your child.

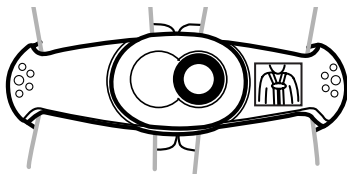

SMALLER CHILD

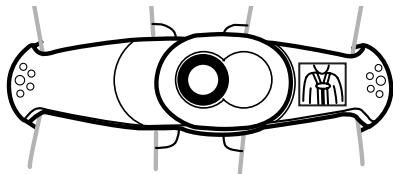

LARGER CHILD

- 8 Push Chest Clip and Shoulder Pads down away from the child's neck and towards the Harness Buckle. Pull on both shoulder straps to remove all slack from below.

SECURING CHILD WITH HARNESS

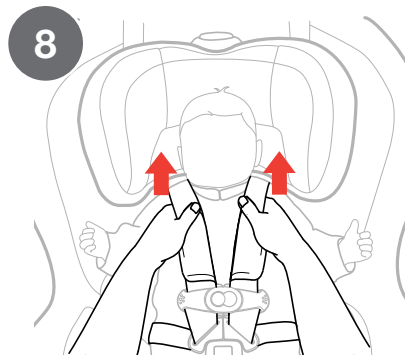
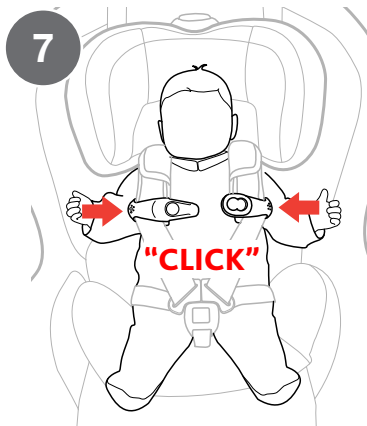

SECURING CHILD WITH HARNESS

- 9 Tighten the harness by pulling slowly on Harness Adjustment Strap until the harness is snug on child (a). If you can pinch a fold in the strap at the child's shoulders, harness is too loose (b). If the harness is too loose pull the Harness Adjuster strap more.
- 10 Move the Shoulder Pads up to the child's shoulders. Slide Chest Clip up to center of child's chest, level with the armpits.

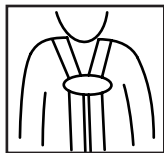

⚠ WARNING - If harness is not snug around your child, child could be ejected in a sudden stop or crash resulting in serious injury or death.

SECURING CHILD WITH HARNESS

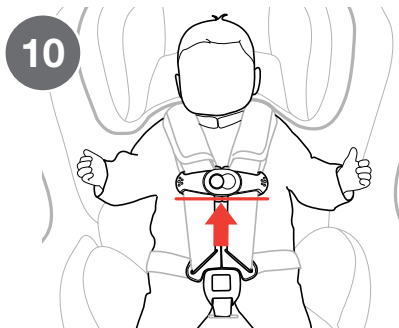
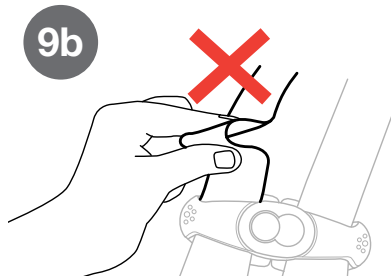
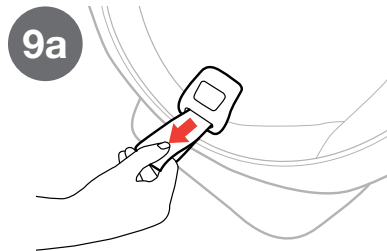

SECURING CHILD CHECKLIST

- ✓ **Harness Straps must be snug.** If you can pinch a fold in the strap, the harness is too loose. A snug strap should not allow any slack. It lies in a relatively straight line without sagging. It does not press on the child's flesh or push the child's body into an unnatural position.

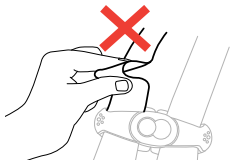

- ✓ **To ensure a better fit for smaller infants, the Newborn Insert may be needed.** Never place extra padding under or behind the child. Only use the Newborn Insert.
- ✓ **Straps must lay flat, free of twists and centered on top of the child's shoulders.**
- ✓ **Check the height of the Harness Straps:** Position the Harness Straps at or below the child's shoulders for REAR-FACING and at or above the child's shoulders for FORWARD-FACING.



REAR-FACING



FORWARD-FACING

SECURING CHILD CHECKLIST

- ✓ Check the position of Chest Clip: Chest Clip should be centered on the child's chest, level with the armpits.
- ✓ Never secure child in Child Restraint with child dressed in bulky garments or heavy clothing. Heavy clothing can prevent harness from being properly tightened around child.
- ✓ Never secure child in Child Restraint with child wrapped in a blanket. To keep child warm, place a blanket over child AFTER you have properly secured and tightened harness around child.

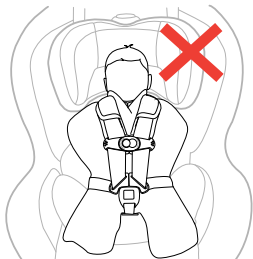

⚠ WARNING - If harness is not snug around your child, child could be ejected in a sudden stop or crash resulting in serious injury or death.

INSTALLATION ON AN AIRCRAFT

When traveling by airplane with your child, Chicco recommends taking the Child Restraint on the airplane with you so that you can use it with your child. Not only will it protect your child during take-off, landing, and turbulence, but also it will give your child a more comfortable place to sit.

- This Child Restraint is certified for use on aircraft. Contact airline about their policy.
- Use this Child Restraint only on FORWARD-FACING aircraft seats.
- Install Child Restraint on an aircraft the same way it is installed in a vehicle when using a vehicle lap belt. Reference Rear-Facing on page 38 or Forward-Facing on page 56.

PAGE INTENTIONALLY LEFT BLANK

CUP HOLDER

⚠ WARNING - PLASTIC CONTAINERS ONLY - No glass or metal containers. Only use cups with less than 12 oz. capacity. Never place sharp or pointed objects in Cup Holder. In a crash these objects could hit you or your child and cause serious injuries.

- 1** Slide Cup Holder into either side of Child Restraint where indicated by the Cup Holder icon.

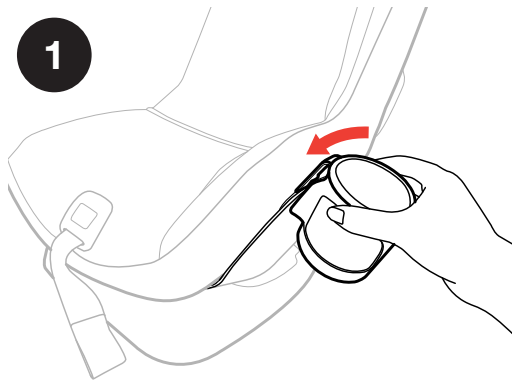

CLEANING AND MAINTENANCE

1 REMOVING SHOULDER PADS:

Unhook the Velcro and remove Shoulder Pads as shown.

2 INSTALL SHOULDER PADS:

Re-attach Shoulder Pads by folding the Velcro Tab over the Harness Strap
(a). Secure both Velcro Tabs together (b). Make sure they are oriented as shown (c).

CLEANING AND MAINTENANCE

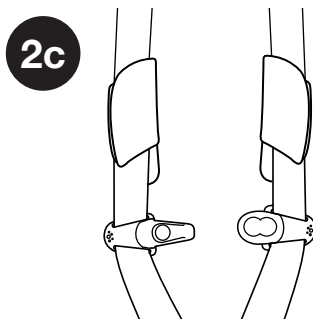
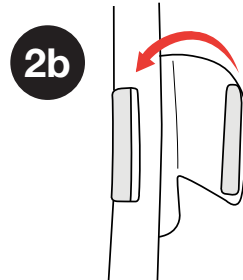
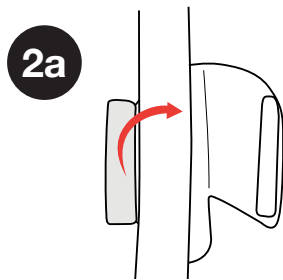
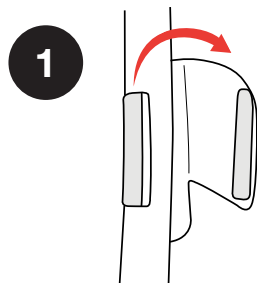

CLEANING AND MAINTENANCE

3 REMOVING SOFT GOODS:

Adjust Head Rest to its highest position. Unsnap Head Rest and pull up on the fabric to reveal two hooked elastic strings (a). Unhook both elastic strings and remove.

Pull seat padding away from the Harness Release button (b). Unsnap each side of the back padding and pull forward to reveal seat bottom.

Unhook the Velcro straps from both sides of Child Restraint on the inside of seat shell (c). Pull padding and Velcro straps out from both sides of Child Restraint (d). Carefully pull seat padding away from Child Restraint.

4 INSTALL SOFTGOODS:

Reverse the removing instructions above to reinstall.

⚠ NEVER use Child Restraint without the Seat Pad.

CLEANING AND MAINTENANCE

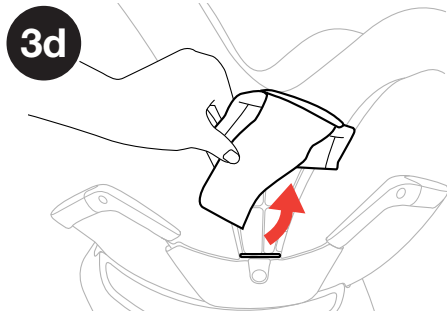
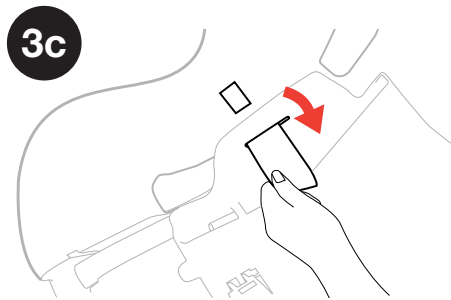
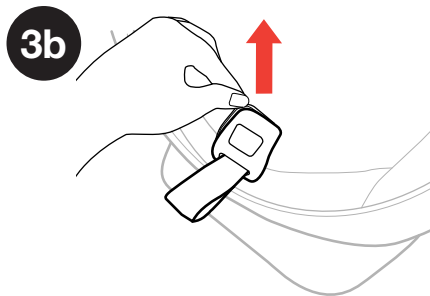
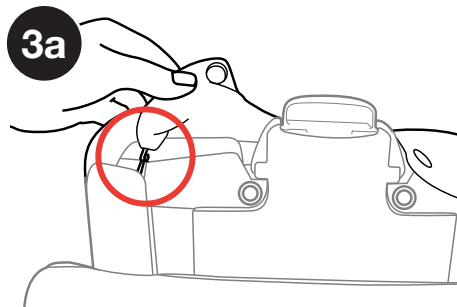

CLEANING AND MAINTENANCE

5 REMOVING CROTCH STRAP:

Fully recline the seat (position 1). Slide the button on the Crotch Strap lock while pulling up on the Crotch Strap to open the compartment (a). Turn metal bar slightly on underside of seat and get corner to go through slot (b). Push metal bar through slot while pulling crotch belt out (c).

⚠ NEVER use Child Restraint without the Crotch Strap installed.

6 INSTALL CROTCH STRAP:

Reverse the removing instructions above to reinstall.

⚠ DO NOT USE Child Restraint if any part of the harness is damaged. For proper removal and installation of the harness straps visit the Chicco website at www.chiccousa.com or call 1-877-424-4226.

CLEANING AND MAINTENANCE

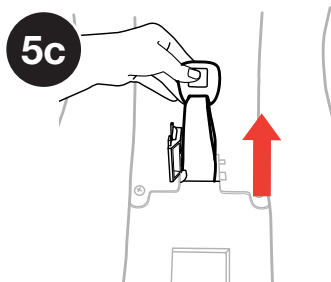
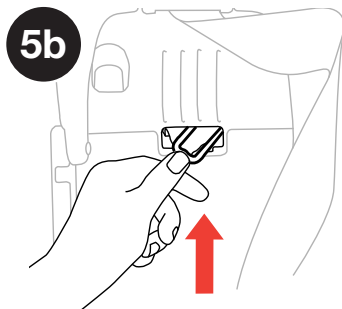
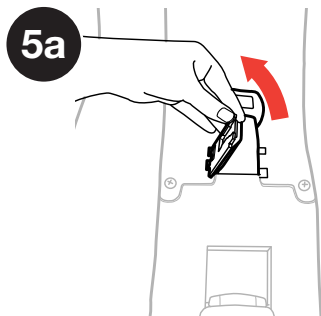

CLEANING AND MAINTENANCE

⚠ DO NOT USE BLEACH, solvents or household cleaners as they may weaken plastics and straps.

⚠ DO NOT USE SOAPS OR LUBRICANTS on Buckle or LATCH hardware. It may cause them to malfunction.

- **Fabrics may be spot-cleaned:**

Hand wash using mild soap and water, or machine washed in cold water on delicate cycle using mild detergent. Hang to dry. See page 96 for removal instructions.

- **Cleaning Shoulder Pads:**

Hand wash using mild soap and water. Hang to dry.

- **Cleaning Plastics:**

Sponge clean using warm water and mild soap. Towel dry.

- **Cleaning Harness:**

Sponge clean using warm water and mild soap. Air dry.
Do NOT machine wash.

- **Cleaning LATCH Straps:**

LATCH Straps cannot be replaced. Sponge clean using warm water and mild soap. Air dry.

- **Cleaning Buckle and LATCH Hardware:**

Sponge clean, using warm water and mild soap. If debris in buckle, remove and rinse in warm cup of water. Air dry. See page 98 for removal instructions.



Do **NOT** remove LATCH or Adjuster straps. For additional information visit the Chicco website at www.chiccousa.com or call 1-877-424-4226.

