



KidFit[®] 2-in1 Booster User Guide

TO USE THIS BOOSTER, CHILD MUST BE AT LEAST

4 YEARS OLD | **40 POUNDS** | **38" TALL**

For future use,
STORE USER GUIDE
in location on
bottom of base.

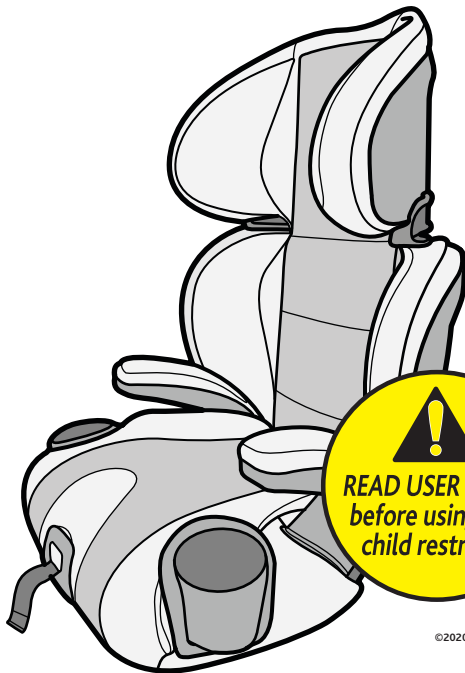
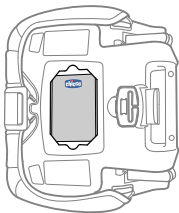

If you have any problems with your Chicco Booster Seat, or any questions regarding installation or use, please call:

Chicco Customer Service
1-877-424-4226

Please have Model and Serial Number available when you call. These are located on a label on the bottom of the Booster Seat.

For future reference, fill in the information below. The information can be found on the label on the bottom of the Child Restraint.

Model Number: _____

Serial Number: _____

Manufactured In: _____

TABLE OF CONTENTS

Registration and Recall	2	HIGH-BACK MODE	
Child Guidelines	4	Adjusting Backrest Height	32
Safe Use Checklist	6	Install High-Back Booster Seat	34
Important Warnings	8	Securing Child in Booster Seat	38
Best Practices	12		
Need Help?	13	BACKLESS MODE	
		Removing Backrest	46
BOOSTER SEAT OVERVIEW		Using Shoulder Belt Clip	50
Booster Seat Components	14	Install Backless Booster Seat	52
High-Back Mode	16	Securing Child in Booster Seat	56
Backless Mode	18	Adjusting Shoulder Belt Clip Height	58
		SAFETY INFORMATION	
VEHICLE INFORMATION		Secure Child Checklist	62
Vehicle Seating Positions	20	Booster Seat Safe Use Checklist	64
Vehicle Seat Belts	22		
What is LATCH?	24	ADDITIONAL INFORMATION	
		Installation on an Aircraft	66
ASSEMBLY INFORMATION		Cup Holder	68
Assembly	26	Release LATCH Connectors	70
		Removing Fabric Covers	72
		Cleaning and Maintenance	90

Please complete the Registration Card that came with your Booster Seat and mail it promptly.

Child Restraints could be recalled for safety reasons. You must register this restraint to be reached in a recall. Send your name, address, e-mail address if available, and the restraint's model number and manufacturing date to:

Artsana USA, Inc.
1826 William Penn Way
Lancaster, PA 17601
or call 1-877-424-4226

or register online at <http://www.chiccousa.com/carseatregistration.aspx>

For recall information, call the U.S. Government's Vehicle Safety Hotline at 1-888-327-4236 (TTY: 1-800-424-9153), or go to <http://www.NHTSA.gov>.

PAGE INTENTIONALLY LEFT BLANK

CHILD GUIDELINES

This Booster Seat is designed for children who demonstrate an ability to sit in a seat belt and meet the following requirements. **ONLY** use this Booster Seat if the child meets the following requirements:

- Child is at least 4 years old.
- Child can sit relatively still, in the same seated position throughout the car ride.
- Child can leave the shoulder and lap belt properly positioned on their body, and can do this every time in the car.
- Weight is between 40 and 110 pounds (18 and 50 kg).
- Height is between 38-57 inches (97-145 cm).

▲ YOUR CHILD'S SAFETY DEPENDS ON YOU! You **MUST** follow the detailed instructions in this User Guide to ensure the steps in this User Guide are performed correctly!

CHILD GUIDELINES



High-Back Mode
on page 16.

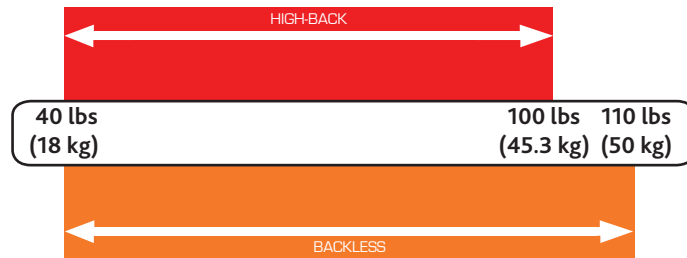

Backless Mode
on page 18.



SAFE USE CHECKLIST

- Make sure your child can sit in the seat properly and meets the requirements listed in the "Child Guidelines" section on page 4:
- Choose the appropriate Booster Seat configuration:
 - HIGH-BACK MODE** requirements on page 16
 - BACKLESS MODE** requirements on page 18
- Select a safe seating location in your car:
Refer to the "Vehicle Seating Positions" section on page 20 and 21.
- Secure your child:
Refer to the "Safety Information" section on page 62.

SAFE USE CHECKLIST

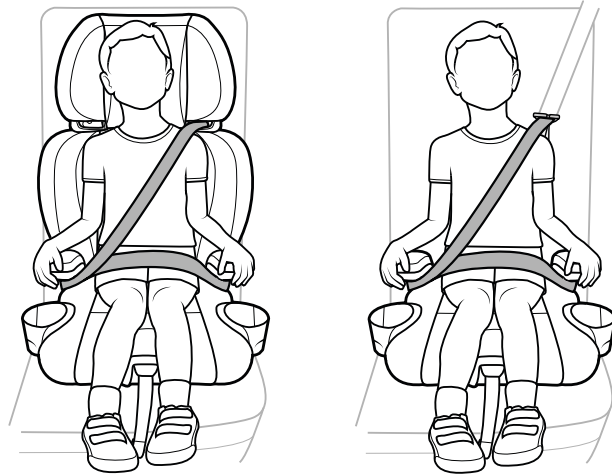



FAILURE TO FOLLOW THESE INSTRUCTIONS AND THE PRODUCT LABELS CAN RESULT IN SERIOUS INJURY OR DEATH TO YOUR CHILD.

Take Time to Read This User Guide

- Carefully read and understand all instructions and warnings in this User Guide. Your child's safety depends on you knowing how to setup, install and use this Booster Seat properly.
- Before installing this Booster Seat in a vehicle, be sure to also check the vehicle owner's manual for information on proper installation.
- **NEVER** allow others to use this Booster Seat until they have read and understood all instructions in this User Guide.
- This Booster Seat is not intended for use outside of the vehicle.

Make Sure Child Fits This Booster Seat

- Use **ONLY** with children who weigh between 40 lbs (18 kg) and 110 lbs (50 kg) and whose height is 38-57 inches (97-145 cm). Determine the right installation setup for your child's age, weight, height, and ability to sit properly at all times.



Install Child Restraint Correctly

- **DO NOT PLACE THIS BOOSTER SEAT IN A VEHICLE SEATING LOCATION WITH A FRONTAL AIR BAG, UNLESS THE AIR BAG CAN BE TURNED OFF.** If the airbag inflates, it can cause serious injury or death to your child. For vehicles with side air bags, refer to your vehicle owners manual for information on your booster seat installation.
- **ALWAYS** install this Booster Seat in a back seat if possible.

According to accident statistics, children are safer when properly restrained in a rear seating position rather than in the front seat.

- **NEVER** install in rear facing, side facing or on the back of a folded down vehicle seat.
- **NEVER** use this Booster Seat with only a Vehicle Lap Belt.
- Use only the vehicle's lap and shoulder belt system when restraining the child in this booster seat.
- To avoid injury to others, **ALWAYS** secure this Child Restraint with the vehicle's Lap-Shoulder Belt when **unoccupied**.
- **DO NOT** use this Booster Seat beyond the "Do Not Use After" date. Check manufacturer's label on underside of Booster Seat.



Secure Child Properly

- Position Lap-Shoulder Belt on your child. A loose or improperly positioned Lap-Shoulder Belt could cause the child to be ejected in a sudden stop or crash, resulting in serious injury or death.
- Make sure vehicle Lap-Shoulder Belt is not loose. The belt must be kept snug across child's thighs and resting on the shoulder and across the center of the chest.
- **NEVER** use clothing or blankets that interfere with fastening or tightening the Lap-Shoulder Belt. An unsecured child could be ejected in a sudden stop or crash!
- **ALWAYS** check to make sure the vehicle seat buckle is securely latched.
- **NEVER leave your child unattended in the vehicle.**
- Do not allow children to play in or around the Booster Seat.



Check Condition of Restraint

- **DO NOT** use if the vehicle belts are cut, frayed or damaged.
- **DO NOT use any accessories, pads or products not included with this Booster Seat, unless approved by Chicco USA.** Doing so will void the warranty of this Booster Seat.
- **You MUST replace this Booster Seat if it has been involved in a crash, even if you cannot see visible damage.** A damaged Booster Seat may not protect your child in a future crash.
- **Do not modify your Booster Seat.**
- **Do not use Booster Seat if any component is damaged, broken, or missing.** Call 1-877-424-4226 to find out if the damaged part or parts can be replaced.

- Ensure all vehicle occupants are properly restrained before traveling. Unrestrained occupants can be thrown around and may be seriously injured or seriously injure other occupants in a sharp turn, sudden stop or crash.
- Do not leave loose objects, such as books, bags, etc., in the back of the vehicle. In the event of a sharp turn, sudden stop, or crash, loose objects can be thrown around and possibly cause serious injury to vehicle occupants.
- Cover the Booster Seat when the vehicle is parked in sunlight. Parts of a Booster Seat can become very hot if left in the sun. Contact with these parts can burn a child's skin. Always check the surface of any metal or plastic parts before putting your child in the Booster Seat.
- To avoid strangulation, do not allow children to play with vehicle seat belts. If possible, move unused belts out of reach.
- Do not use anything to raise the Booster Seat off the vehicle seat such as a noodle or towel. In a sharp turn, sudden stop, or crash, the Booster Seat could slide and potentially cause serious injury.
- Never use a second-hand Booster Seat with an unknown history.
- Never use any accessories that are not included with this child restraint, unless specifically approved by Chicco. For more information, go to www.chiccousa.com.

Need Help Securing Your Booster Seat?

The following sources are available to help ensure your Booster Seat is properly installed:

- Contact Chicco, USA by visiting our website at www.chiccousa.com or calling our Customer Service 1-877-424-4226. Please have Model and Serial Number available when you call. These are located on a label on the bottom of the Booster Seat.
- Refer to your vehicle manual for Booster Seat installation tips.
- Contact a certified Child Passenger Safety Technician in your area by visiting safercar.gov and select "Find Local Child Seat Help" or call 1-866-SEAT CHECK (1-866-732-8243).

BOOSTER SEAT COMPONENTS

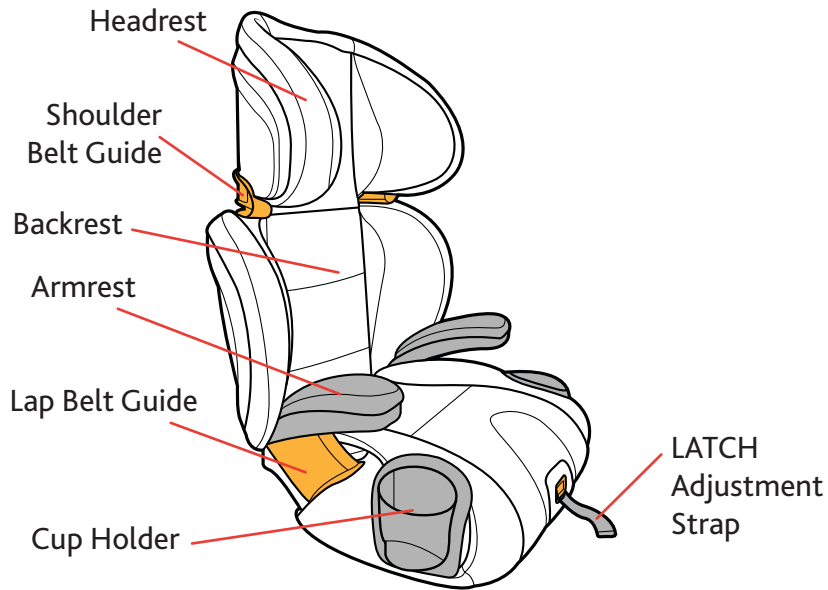

BOOSTER SEAT COMPONENTS

Shoulder Positioning Clip & Webbing (Backless Mode)

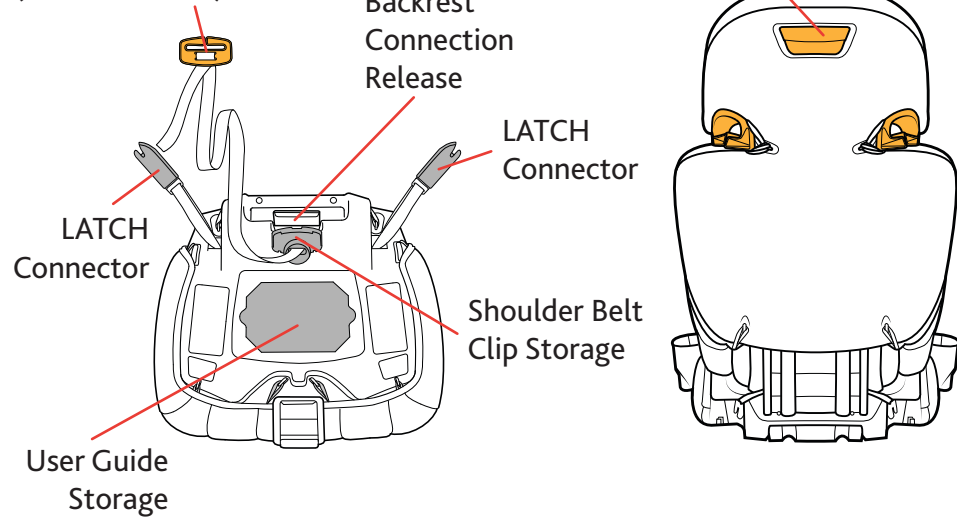

HIGH-BACK MODE

▲ **WARNING!** **High-Back Mode** use of this Booster Seat is ONLY for children who meet ALL of the requirements shown here. If the child is not within these requirements because they are too small, select a different child seat (such as a forward facing harness seat or convertible seat).

To ensure a correct installation of the Booster Seat, you must follow the step by step instructions in this user guide.

HIGH-BACK MODE

High-Back Mode:
40 – 100 lbs (18 – 45.3 kg)

Use **High-Back Mode** with children:

- Who are at least four years old.
- Who weigh between 40 and 100 lbs (18 – 45.3 kg).
- Who are 38" to 57" (97-145 cm) tall and the child's ears are below the headrest.
- Who demonstrate an ability to sit relatively still and properly in a seat belt at all times.

See Adjusting Shoulder Belt Guide Height on page 38.



BACKLESS MODE

▲ WARNING! Backless Mode use of this Booster Seat is ONLY for children who meet ALL of the requirements shown here. If the child is not within these requirements because the child is too small, review the HIGH-BACK BOOSTER MODE guidelines on page 16 or select a different child seat.

To ensure a correct installation of the Booster Seat, you must follow the step by step instructions in this user guide.

BACKLESS MODE

Backless Mode:
40 – 110 lbs (18 – 50 kg)

Use **Backless Mode** with children:

- Who are at least four years old.
- Who weigh between 40 and 110 lbs (18 – 50 kg).
- Who are 38" - 57" (97-145 cm) tall and the child's ears are below vehicle seat.
- Who demonstrate an ability to sit relatively still and properly in a seat belt at all times.

See Adjusting Shoulder Belt Clip Height on page 58.





▲ WARNING! WHEN USING THIS CHILD RESTRAINT, DO NOT PLACE THIS CHILD RESTRAINT IN A VEHICLE SEATING LOCATION WITH A FRONTAL AIR BAG, UNLESS THE AIR BAG CAN BE TURNED OFF.

The back seat is the safest place for children 12 and under. See your vehicle owner's manual for Booster Seat installation and instructions.

Some vehicles have no seating positions which are compatible with this Booster Seat. Only forward-facing vehicle seats can be used with this Booster Seat. Never use side or rear facing seats. If in doubt, contact the vehicle manufacturer for assistance.



This Booster Seat must be installed in a vehicle seat with a 3-point seat belt (shoulder belt and lap belt). **NEVER** use lap belt only.

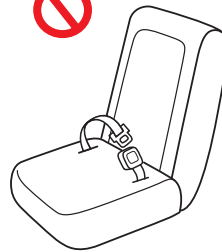

Vehicle seat belts differ from vehicle to vehicle. Refer to your vehicle owner's manual for specific information about seat belts and their use with booster seats.

Shoulder belt with switchable retractor:

Refer to your vehicle owners manual for information regarding switchable retractors and booster seat use.

Inflatable seat belts:

Follow the vehicle manufacturer's instructions for use with this Booster Seat.

The following types of vehicle belts **MUST NOT** be used to install this **Booster Seat**.

If any of the belt types listed below are in the chosen seating position, you must choose another vehicle seating position.

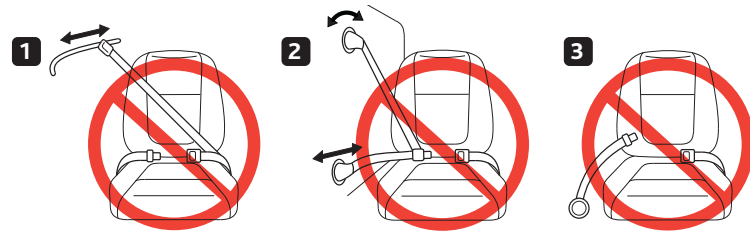

1. Never use a Lap belt with motorized Shoulder belt. **3. Never use a Lap-only belt.**

2. Never use vehicle belts that are attached to the door or that move along a track.

WHAT IS LATCH?

▲ WARNING: This Booster Seat is designed to be used with lower LATCH anchors at the standard spacing (11 inches (28 cm)) **ONLY!** Refer to vehicle owner's manual for information about LATCH and Booster Seat installation positions.

LATCH = Lower Anchors and Tethers for Children

On this Booster Seat, **Lower Anchors are only used to restrain the Booster Seat, not to restrain your child. To secure your child, a vehicle Lap-Shoulder Belt MUST be used.**

Please refer to the vehicle owner's manual for designated Lower Anchor locations in vehicles. Some vehicles owner's manual use the term "**ISOFIX**". **ISOFIX** lower anchors may also be used to secure the Booster Seat.

If the vehicle is equipped with **LATCH**, the vehicle lower anchor points may be visible at the seat crease. If not visible, the seating position may be marked with a symbol as shown or a colored dot. The top tether anchor is not used with this Booster Seat.

WHAT IS LATCH?

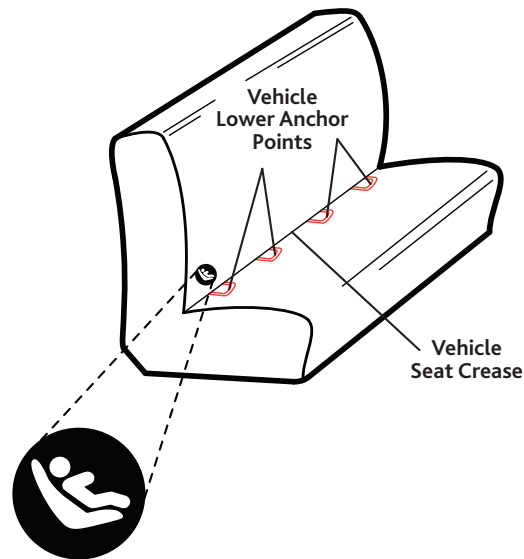

1 Assemble the Cup Holder

- 1** Match up the letter (L or R) on the bottom of the Cup Holder with the matching letter on the Booster Seat and insert the Cup Holder into the correct side.

Make sure the Cup Holder lip fits behind the groove on the Booster Seat bottom, as shown.

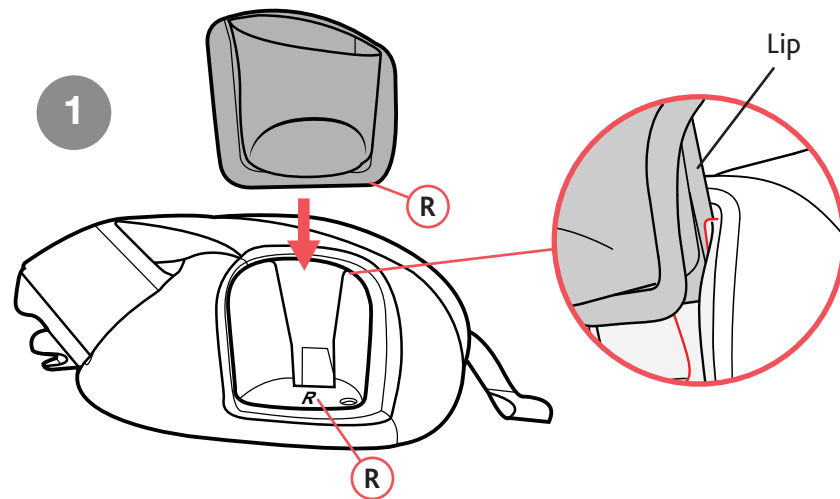

2 Assemble the Armrests

- 2 Attach both Armrests to the Booster Seat Bottom, as shown. Press firmly on Armrests until they click into place. Pull up on both Armrests to make sure they are securely attached.

▲ Never use Booster Seat without Armrests attached.

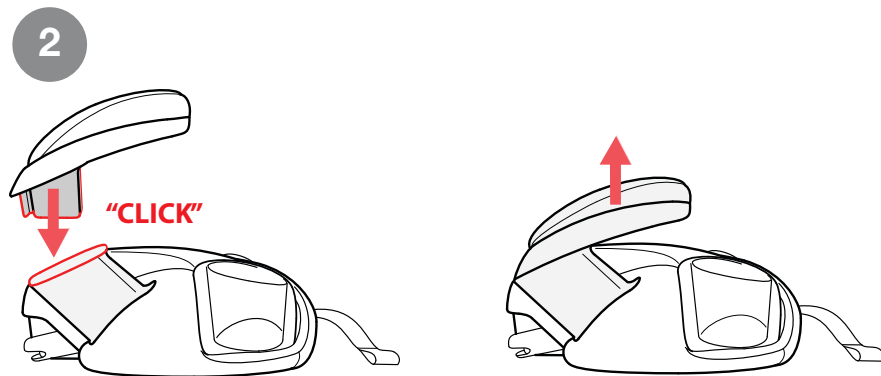

3 Assemble the Backrest

3 Attach the Backrest to the Booster Seat Bottom, by hooking the Backrest over the seat bar hinge on the seat bottom, as shown.

4a Slide the edge of the Fabric Panel between the Fabric Cover and the Seat Back Frame. Be sure Fabric Panel is laying flat against the Seat Back frame to provide padding for your child.

4b Rotate the Backrest up until it clicks into an upright position.

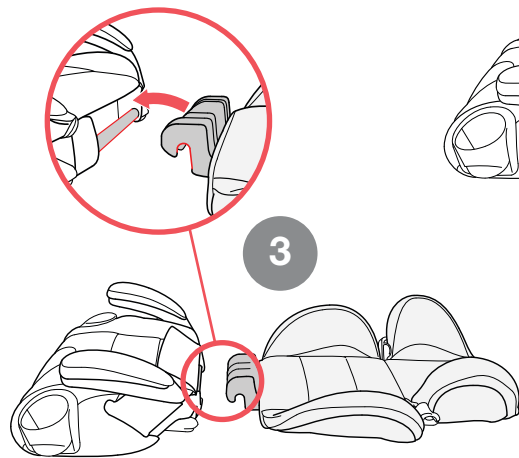
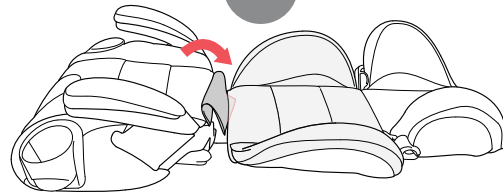
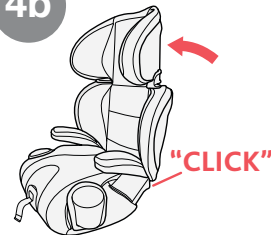
**4a****4b**

ADJUSTING BACKREST HEIGHT

- 1 While holding the Booster Seat firmly with one hand on the seat, use the other hand to squeeze the Height Adjuster Lever located at the back of the Headrest.
- 2 Raise/Lower the Backrest to correctly fit the Booster Seat to your child.

When correct position is reached, release the Height Adjust Lever and slightly raise or lower the Backrest until you hear a click, indicating that the Backrest is locked into position.

The Booster Seat Backrest has 10 height positions to allow the Booster Seat to grow with your child. Ensure that the child's head is positioned correctly within the Headrest and that the Shoulder Belt is placed correctly over the child's shoulder.

ADJUSTING BACKREST HEIGHT

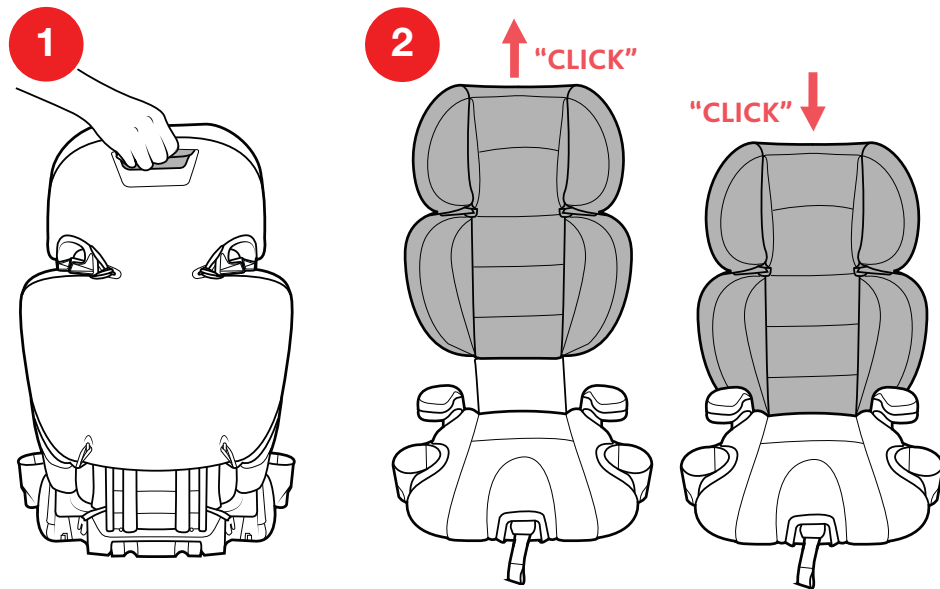

INSTALL HIGH-BACK BOOSTER SEAT

- 1 Place the Booster Seat on the vehicle seat, push the Booster Seat Backrest against the back of the vehicle seat.
- 2 Check that the head restraint of the vehicle seat does not interfere with the Headrest of the Booster Seat. If the vehicle head restraint pushes the Booster Seat Headrest forward, raise or remove the vehicle head restraint, if possible. If it is not possible to move the vehicle head restraint out of the way, use the Booster Seat in the Backless Mode. Ensure the child is the proper size to use the Backless Booster Seat. Refer to page 18.

Always replace the vehicle head restraint when the Booster Seat is removed.

INSTALL HIGH-BACK BOOSTER SEAT

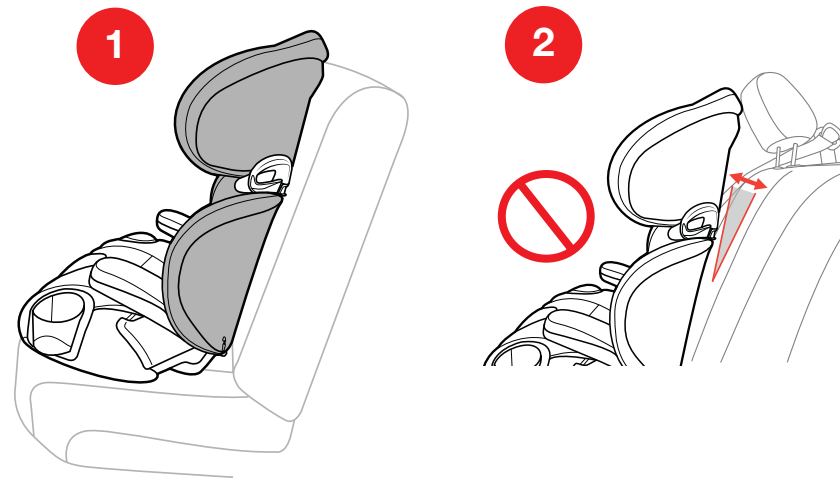

INSTALL HIGH-BACK BOOSTER SEAT

Use of LATCH Connectors with this Booster Seat is optional. If the LATCH Connectors are not used, pull the LATCH Tightening Strap snug so that the LATCH Connectors do not interfere with the seat belt.

- 3** If using the LATCH Connectors, release the LATCH Adjustment Strap, press in the button located on the front of the seat bottom and pull out both LATCH Connectors.
- 4** Locate the LATCH lower anchor bars in your vehicle. Attach both LATCH Connectors to the vehicle lower anchor bars.
- 5** Pull on the LATCH Adjustment Strap and push back on the seat bottom to snug up the Booster Seat to the vehicle seat back.

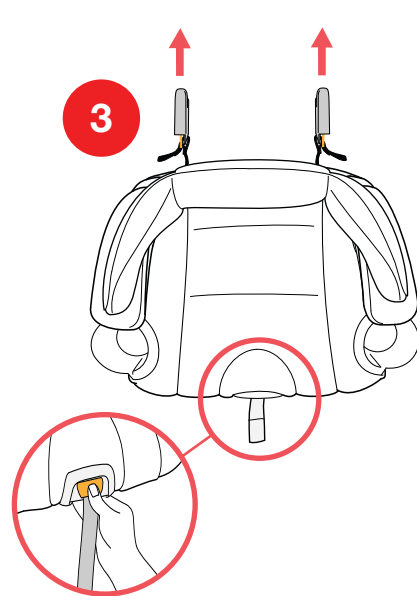

INSTALL HIGH-BACK BOOSTER SEAT

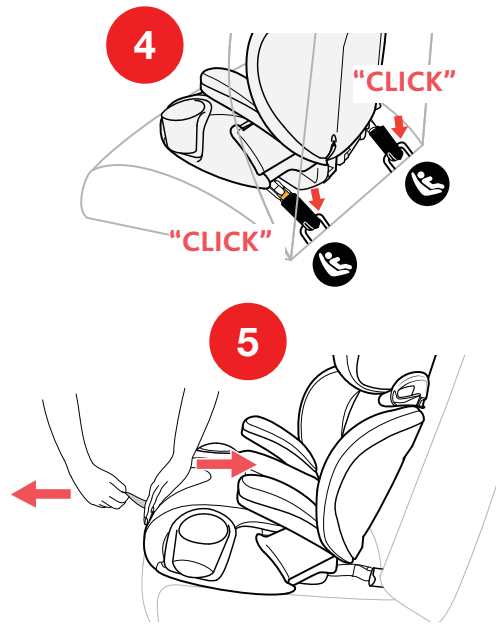

SECURING CHILD IN BOOSTER SEAT

- 1 Place the child into the Booster Seat, making sure the child is sitting with his/her back against the Booster Seat Backrest.
- 2 The Shoulder Belt Guide must be positioned at or just slightly above the child's shoulders. Adjust the seat back to the proper height. Make sure the shoulder belt lays across the shoulder and over the center of the child's chest. The lap belt should lay over the child's thighs.

If Shoulder Belt Guide is **NOT** positioned at or just slightly above the child's shoulders see page 32 for Adjusting Backrest Height.

Child's ears must be below Headrest when sitting on Booster Seat. If the child's ears are above the Headrest, use the Backless Booster Mode refer to page 46.

SECURING CHILD IN BOOSTER SEAT

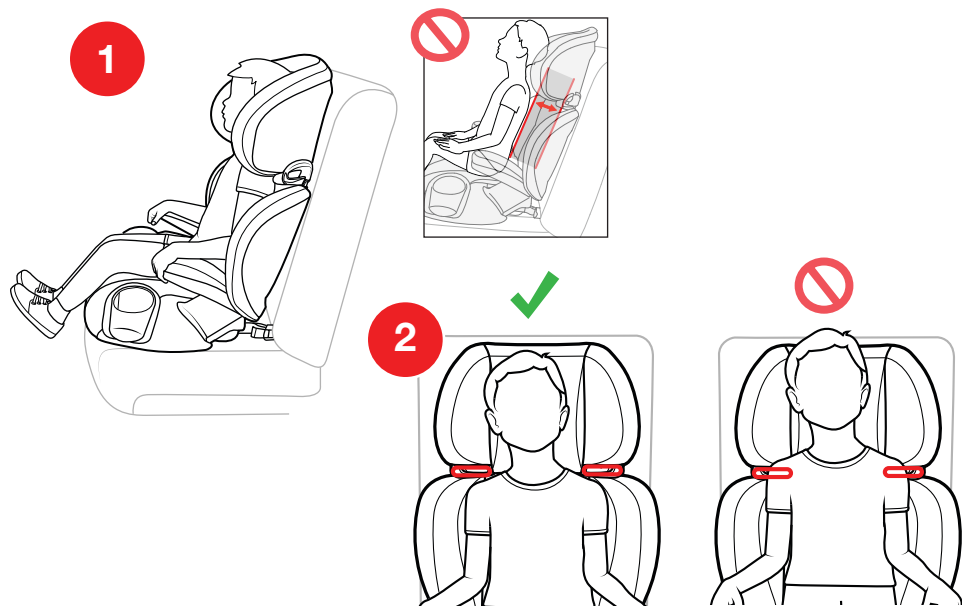

SECURING CHILD IN BOOSTER SEAT

- 3a** Route the lap belt **UNDER** the 1st Armrest, across the child's thighs, then route the shoulder belt and the lap belt **UNDER** the 2nd Armrest closest to the vehicle buckle as shown. Lap-Shoulder belts **MUST** be under the **ARMRESTS**, as shown.
- 3b** Buckle the seat belt.

SECURING CHILD IN BOOSTER SEAT

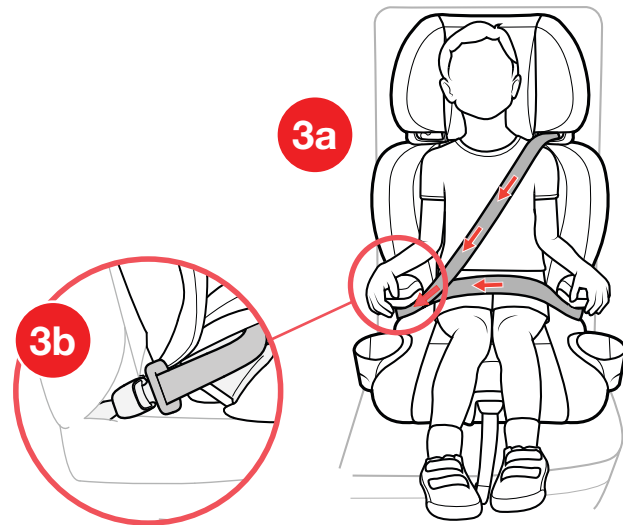

SECURING CHILD IN BOOSTER SEAT

- 4 Slide the shoulder belt through the orange Shoulder Belt Guide (A). Make sure belt is below belt guide clip (B).

The lap belt should lay flat and snug across the child's thighs. And, when the shoulder belt is pulled up, it will lay flat and snug across the child's chest.

The seat belt can remain in the Shoulder Belt Clip until the seat is removed from the Vehicle.

SECURING CHILD IN BOOSTER SEAT

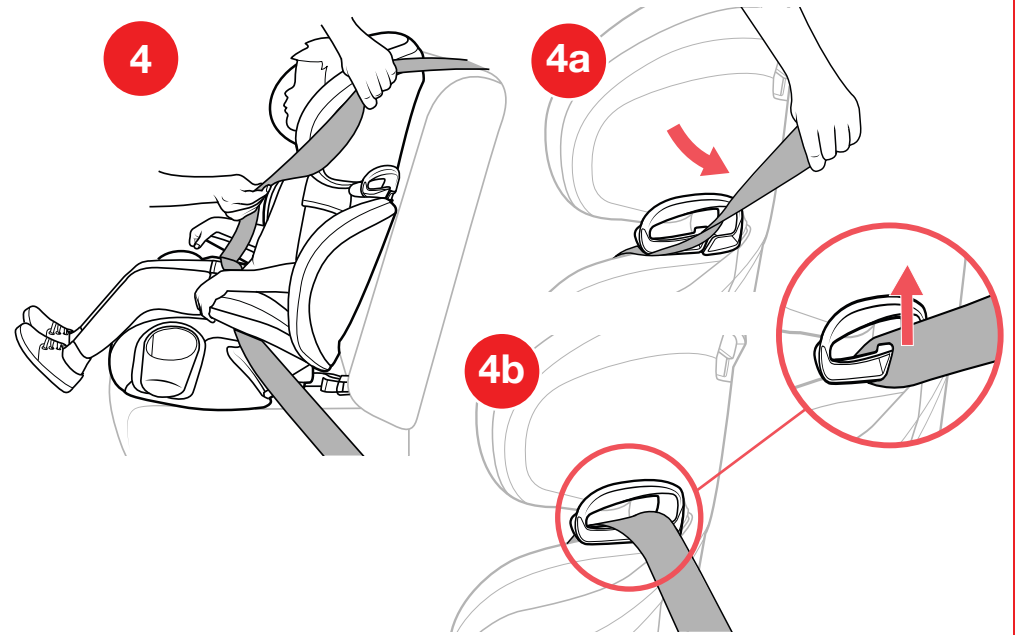

- 5 Ensure the child is secured correctly as shown.

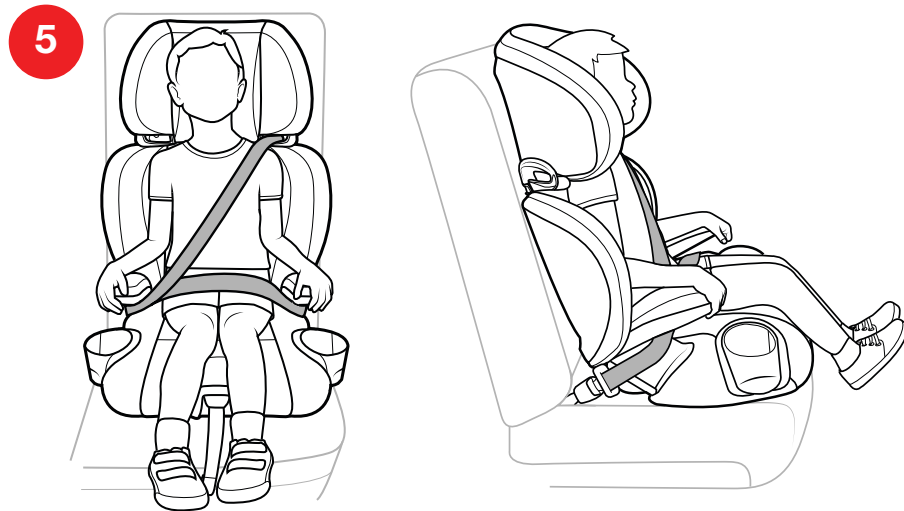

REMOVING BACKREST

- 1 To remove the Backrest, turn the seat over and press down on the Backrest Connection Release at the base of the seat back under the seat bar.
- 2 At the same time rotate the seat back (A) and remove Backrest from the Booster Seat bottom (B), as shown.

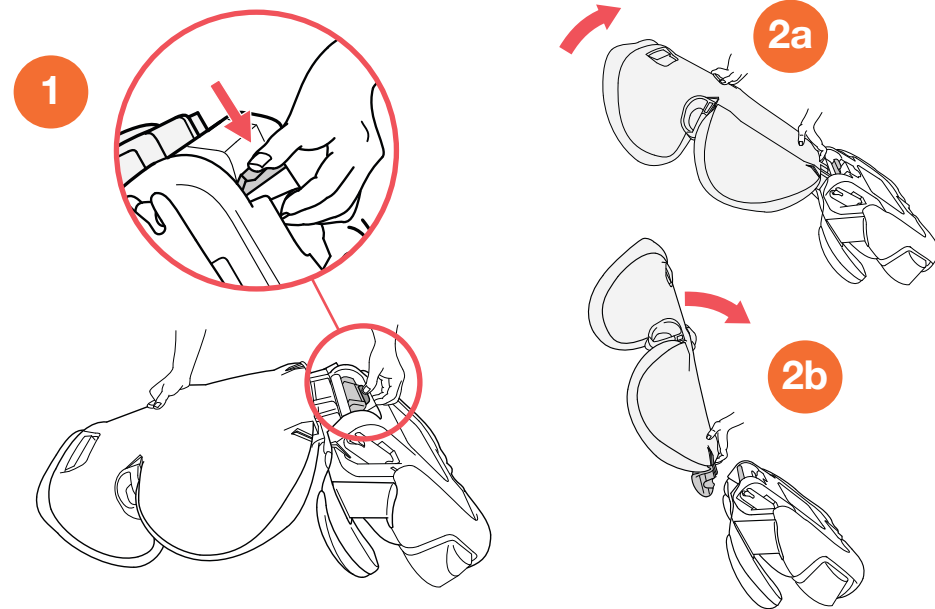

REMOVING BACKREST

- 3 Tuck the Fabric Panel between the fabric cover and the seat surface, as shown.

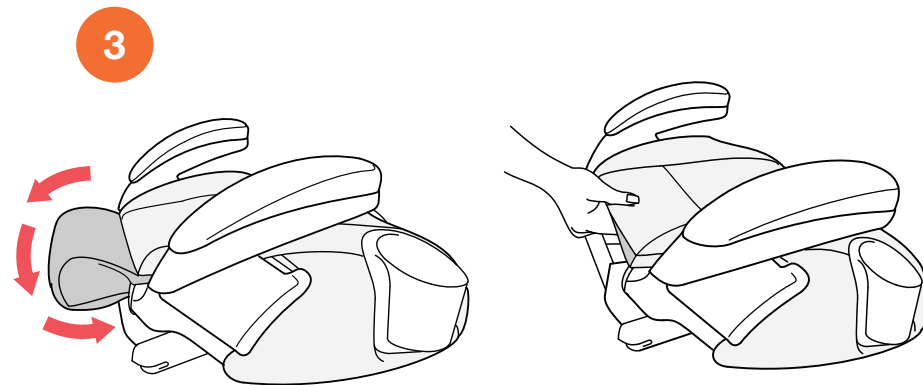

REMOVING BACKREST

USING SHOULDER BELT CLIP

- 1 The Shoulder Belt Clip is stored under the Booster Seat bottom. Remove the Shoulder Belt Clip and Strap stored underneath seat.
- 2 Place the Booster Seat onto the vehicle seat.

USING SHOULDER BELT CLIP

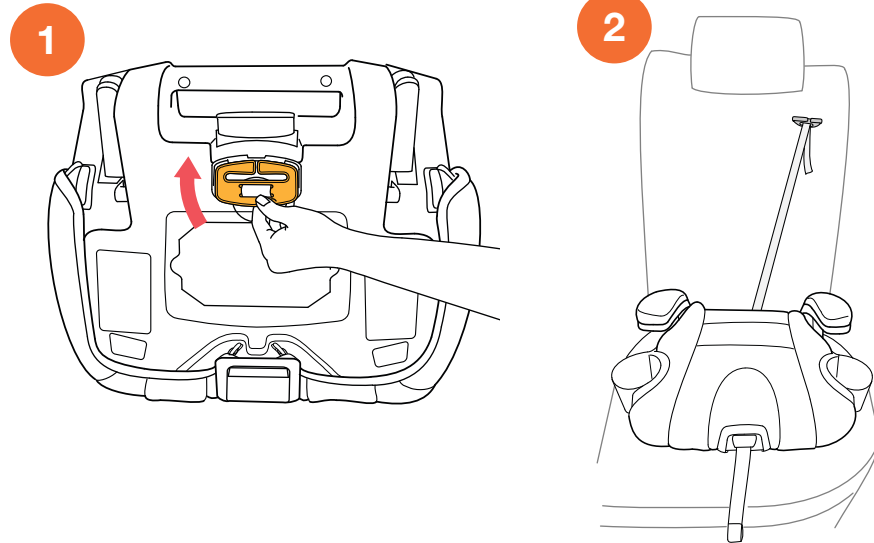

- 3 If using LATCH Connectors, release LATCH Adjustment Strap, press in the button located on the front of the seat bottom (A) and pull out on both LATCH Connectors (B).

Use of LATCH Connectors with this Booster Seat is optional. If the LATCH Connectors are not used, pull the LATCH Adjustment Strap snug so that the LATCH Connectors do not interfere with the seat belt. Skip to "Securing Child in Booster Seat" section page 56.

3a

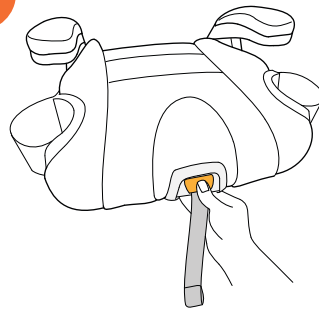

3b

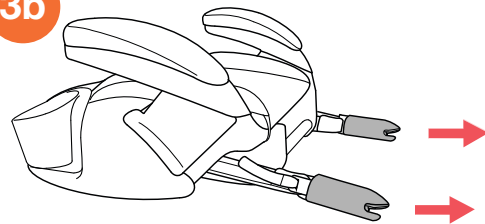

INSTALLING BACKLESS BOOSTER SEAT

- 4 Locate the LATCH lower anchor bars in your vehicle. Attach both LATCH Connectors to the vehicle lower anchor bars.
- 5 Pull on the LATCH Adjustment Strap and push back on the seat bottom to snug up the Booster Seat to the vehicle seat back.

INSTALLING BACKLESS BOOSTER SEAT

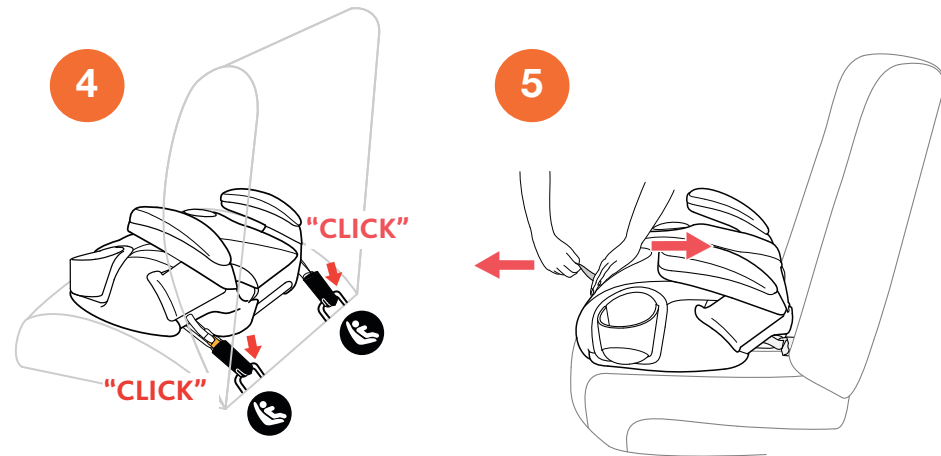

SECURING CHILD IN BOOSTER SEAT

- 1 Place the child into the Booster Seat, making sure the child is sitting with his/her back against the vehicle seat back.

Child's ears must be below vehicle seat back or vehicle head restraint when sitting on Booster Seat. If the child's ears are above the vehicle seat back or vehicle head restraint when it is fully extended, use the High-Back Mode. Refer to page 32.

- 2a Route the lap belt **UNDER** the 1st Armrest, across the child's thighs, Then route the shoulder belt and the lap belt **UNDER** the 2nd Armrest closest to the vehicle buckle as shown. Lap-Shoulder belts **MUST** be under **ARMRESTS**, as shown.
- 2b Buckle the seat belt.

SECURING CHILD IN BOOSTER SEAT

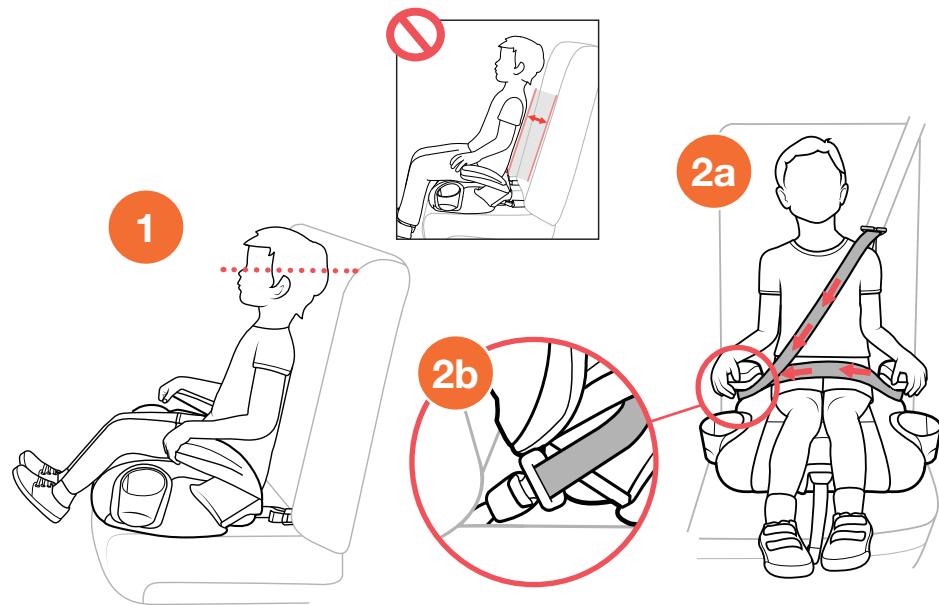

SECURING CHILD IN BOOSTER SEAT

- 3** To adjust the Shoulder Positioning Clip, pull the clip up or down to adjust the Shoulder Positioning Clip to be at or slightly above the child's shoulders.
- 4** Slide the vehicle shoulder belt through the Shoulder Positioning Clip (as shown). Shoulder Positioning Clip must be at child's shoulder. If necessary, readjust the location of the Clip to ensure that the seat belt lays flat and snug across the child's chest and the lap belt lays flat and snug across the child's thighs.

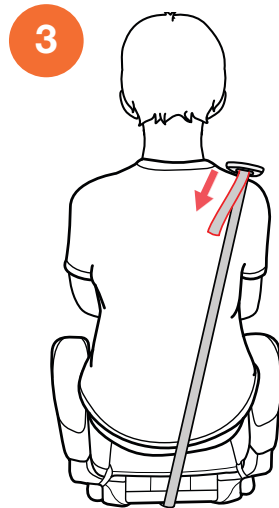

SECURING CHILD IN BOOSTER SEAT

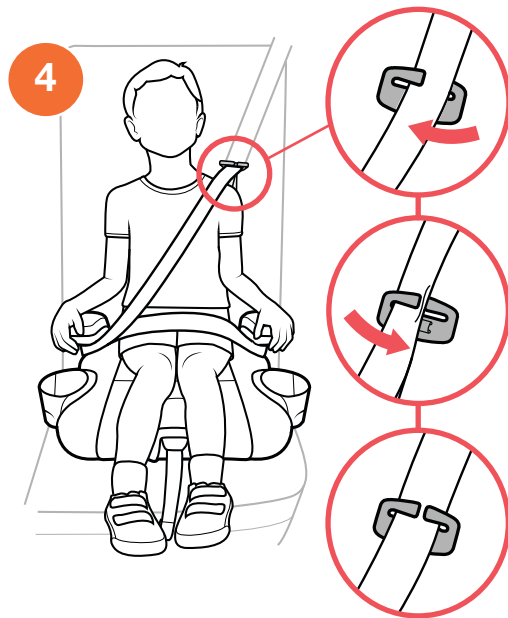

SECURING CHILD IN BOOSTER SEAT

- 5 Child is now secured correctly, as shown.

When using in Backless Mode, the Shoulder Positioning Clip must be used until the seat belt naturally lays flat across the center of the child's shoulder.

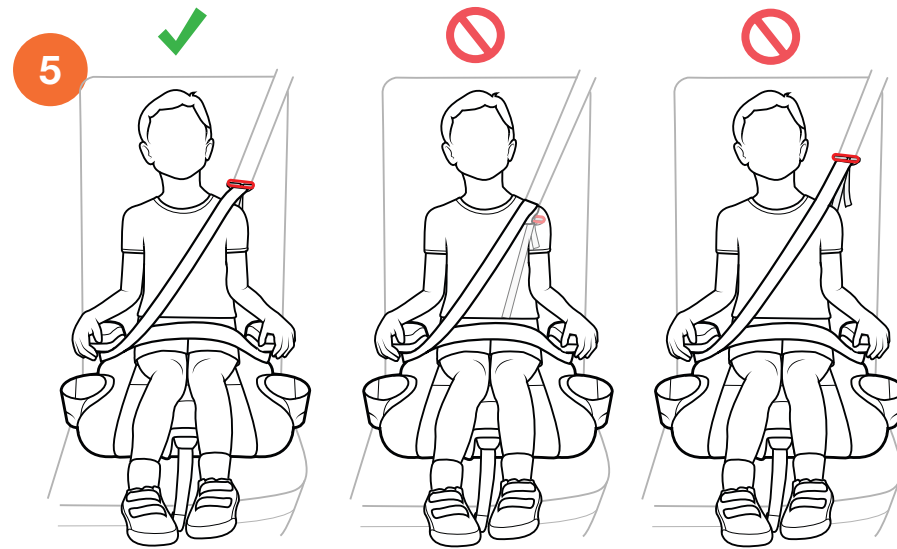

SECURING CHILD IN BOOSTER SEAT

SECURING CHILD CHECKLIST

⚠ **ALWAYS** check to make sure vehicle seat belt is securely buckled. If buckle separates, child could be killed or seriously injured.

- ✓ Check that the seat belt is not twisted.
- ✓ Check that the shoulder belt is snug on the child's shoulder and that it does not rub on the neck. It should lie flat across the child's chest and middle of shoulder. The Shoulder Belt Guide should be at or just above the child's shoulder. If necessary, raise or lower the Booster Seat Backrest.

⚠ **DO NOT** use anything (pillows, blankets, etc.) between the Booster Seat and the vehicle seat or between the child and the Booster Seat. Avoid bulky clothing that interferes with proper seat belt placement. In the event of an accident, the Booster Seat may not operate correctly.

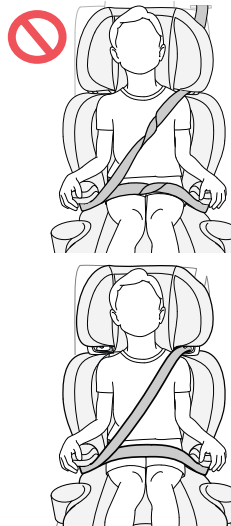

SECURING CHILD CHECKLIST

- ✓ Do not let your child slide forward or downward while in the Booster Seat.



- ✓ Never use the vehicle belt in any position other than those indicated in this User Guide!

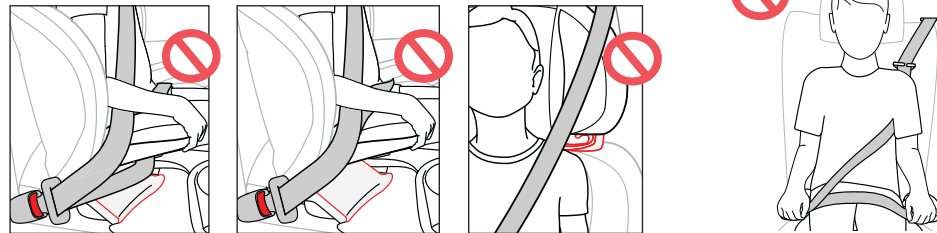

⚠ To avoid injury to others, ALWAYS secure this Booster Seat when unoccupied. An unsecured Booster Seat could injure other occupants in a sudden stop or crash.

Secure the unoccupied Booster Seat with either LATCH or the vehicle belt by following the appropriate steps below. The LATCH system is adequate to secure the Backless Booster Seat, but the Lap-Shoulder belt should be used to secure the High-Back Booster Seat.

- 1 Follow steps 3-5 to use LATCH page 52.
- 2 High-Back Mode, follow steps 3-4 to use Lap-Shoulder belt page 40.
Backless Mode, follow step 2 to use Lap-Shoulder belt page 56.

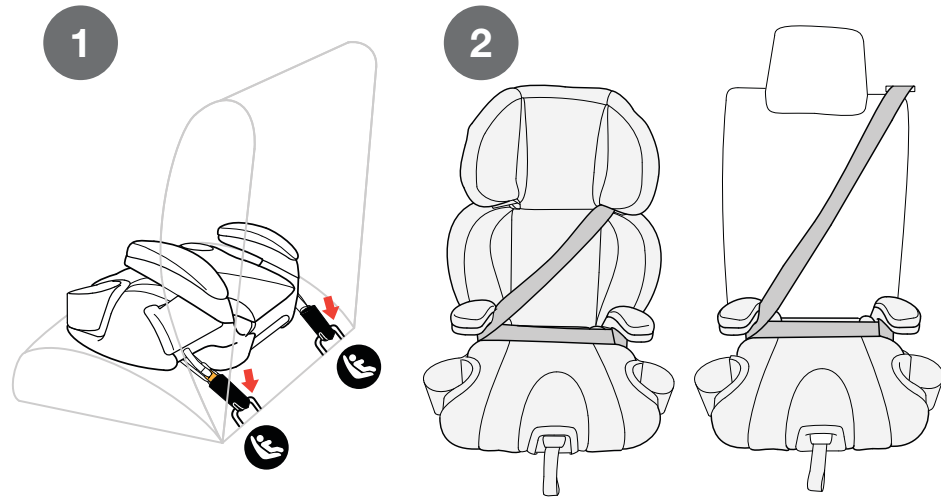

INSTALLATION ON AN AIRCRAFT

- This Booster Seat is NOT certified for aircraft use. Aircraft do not have lap-shoulder belts to secure your child.

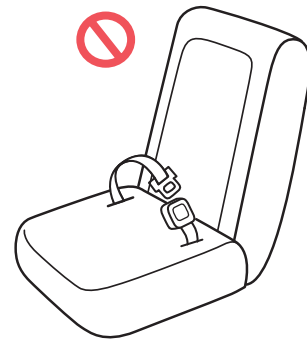
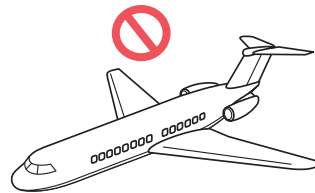

INSTALLATION ON AN AIRCRAFT

CUP HOLDER

⚠ WARNING! DO NOT place hot liquids in cup holder. If spilled, hot liquids could burn child. **PLASTIC CONTAINERS ONLY** - No glass or metal containers. Only use cups with less than 12 oz. (355 ml) capacity. Never place sharp or pointed objects in Cup Holder. In a crash these objects could hit you or your child and cause serious injuries.

- 1** To remove the Cup Holders press in on the release button on the bottom of the Booster Seat.
- 2** The Cup Holders can also be folded in to allow others to sit next to the Booster Seat.

CUP HOLDER

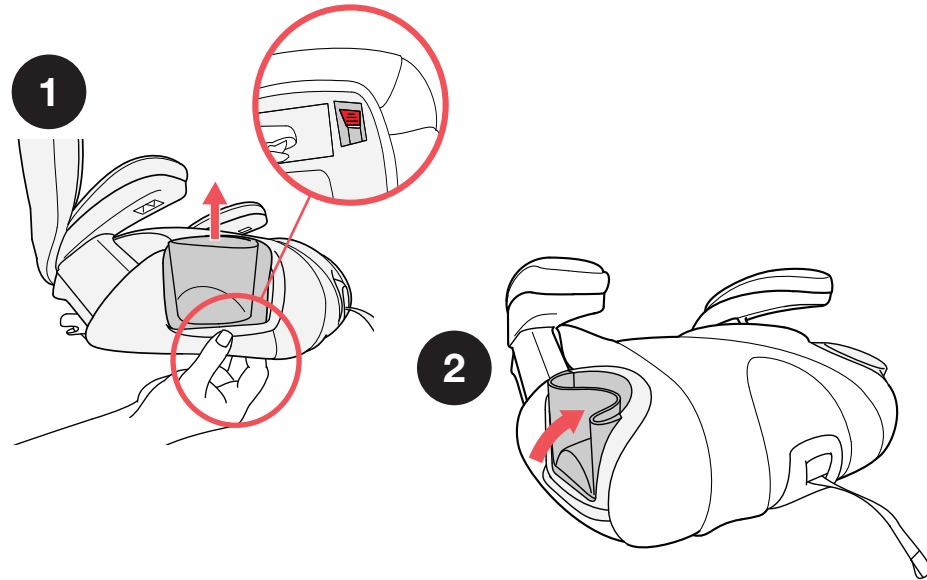

RELEASE LATCH CONNECTORS

- 1** To release the LATCH Connectors and remove the Booster Seat, press in the button located on the front of the seat bottom while pulling the Booster Seat out to loosen the LATCH Connectors.
- 2** Then pull out on the loops on the LATCH Straps, as shown. Pull the LATCH Adjustment Strap tight to store the LATCH Connectors.

RELEASE LATCH CONNECTORS

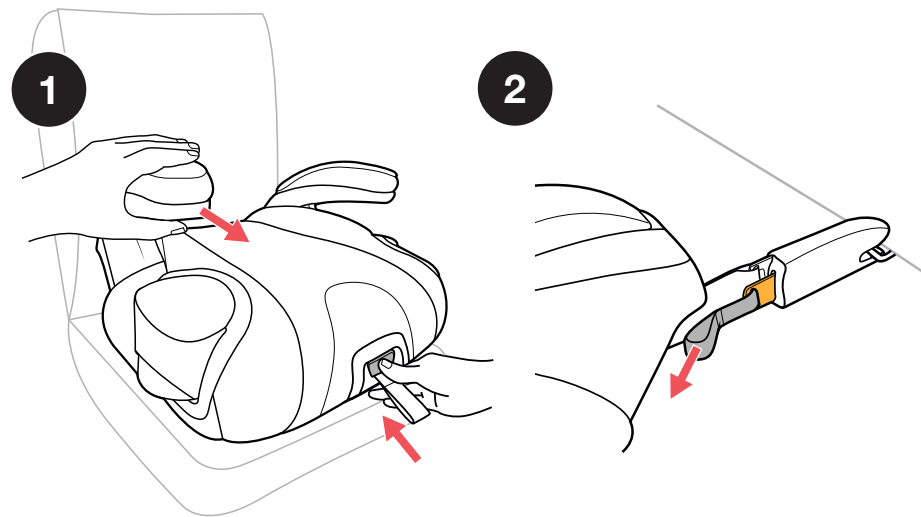

REMOVING FABRIC COVERS

- 1** **Booster Seat bottom**
Remove both Cup Holders and flip the Booster Seat bottom over and unhook 8 elastic loops, as shown.

If Backrest is attached to the seat bottom, see page 46 for removing Backrest.

Both Cup Holders need to be removed before fabric can be removed, refer to page 68.

REMOVING FABRIC COVERS

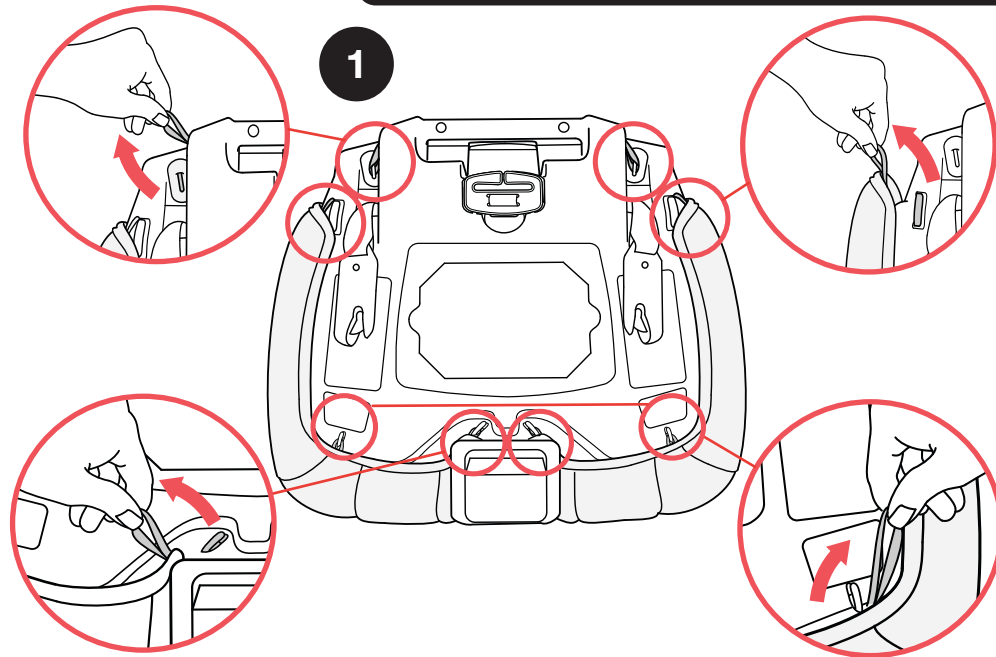

REMOVING FABRIC COVERS

- 2 Flip the fabric over and remove the Foam Pad before washing the fabric. Make sure to insert the Foam Pad into the fabric seat bottom before reinstalling onto the seat bottom frame.

REMOVING FABRIC COVERS

2

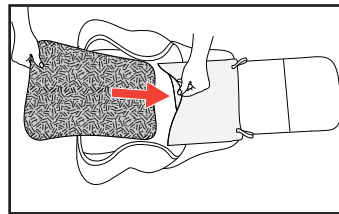
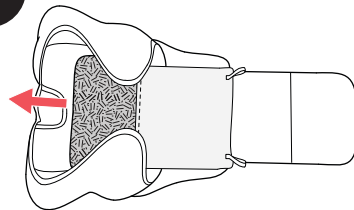

REMOVING FABRIC COVERS

1

Backrest fabric cover

On the Booster Seat Backrest, unhook 6 elastic loops as shown. Four behind the Headrest and two at the bottom of the seat back.

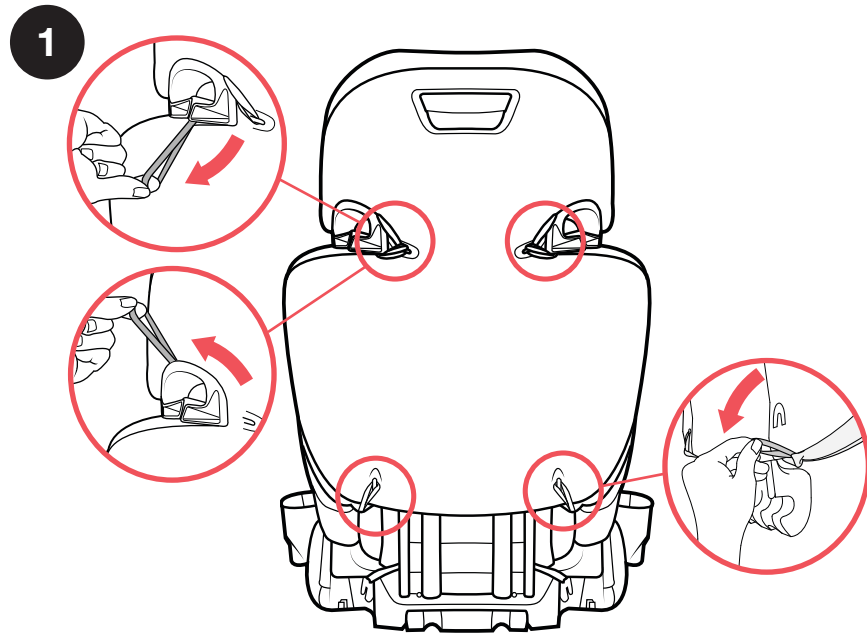

REMOVING FABRIC COVERS

REMOVING FABRIC COVERS

2

Backrest fabric cover

Lift up on the plastic tabs at the top of the Headrest and below the Shoulder Belt Guides, as shown. Pull the Backrest fabric cover forward to remove.

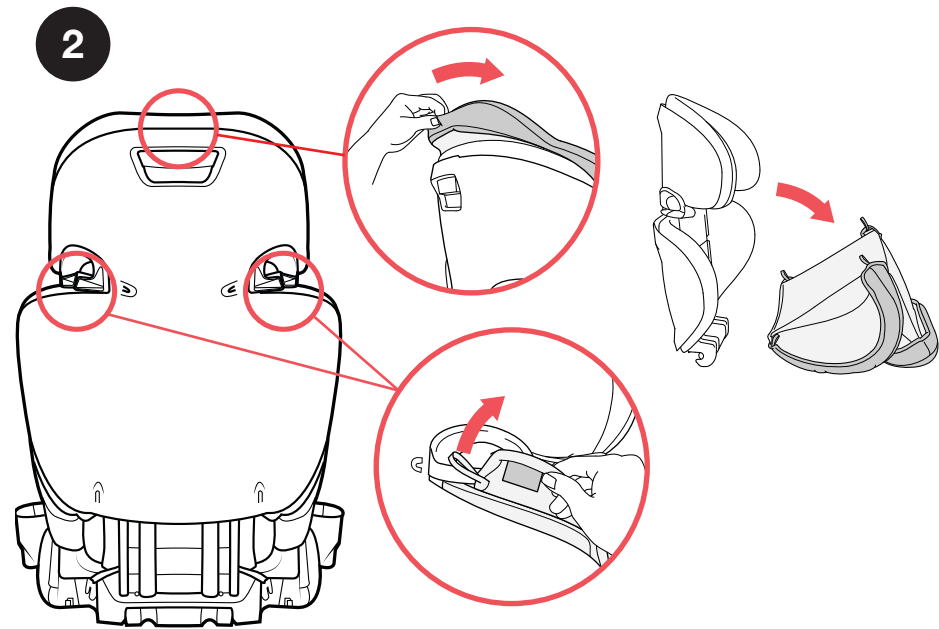

REMOVING FABRIC COVERS

Repeat **Removing Fabric** steps in the reverse order, ensuring that the fabric cover fits onto and around the frame correctly, in particular around the orange belt guides.

- 1 Position the fabric cover on the Booster Seat Backrest and reattach all elastic loops.
- 2 Tuck in the fabric along the Backrest edges.

REMOVING FABRIC COVERS

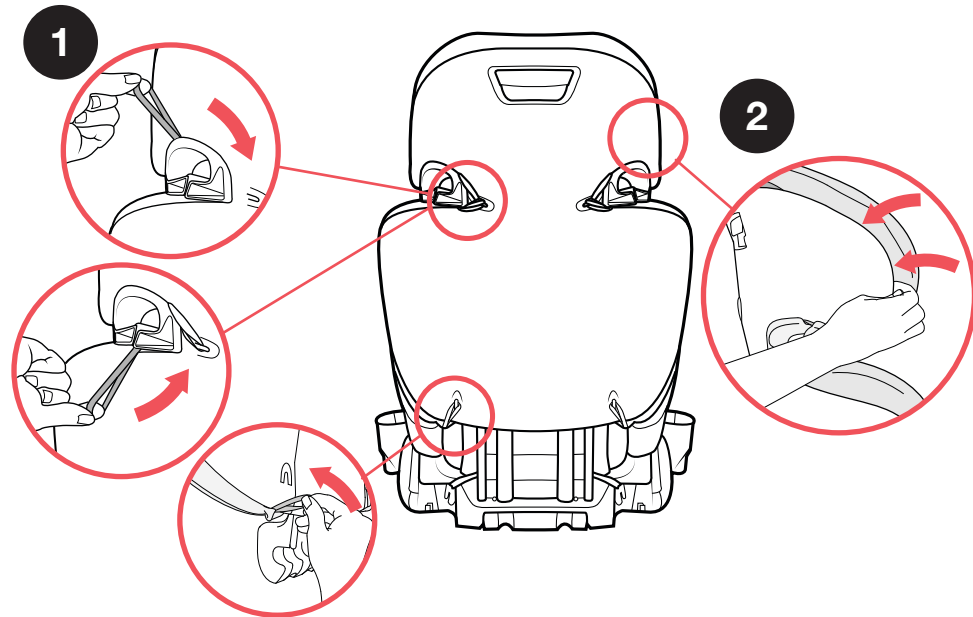

REMOVING FABRIC COVERS

- 3 Insert the plastic tab on the top of the Headrest into the long groove right above the top edge of the Backrest.
- 4 Insert the plastic tab below the Shoulder Belt Guide, slide between the Backrest and foam. Repeat for the other side.

REMOVING FABRIC COVERS

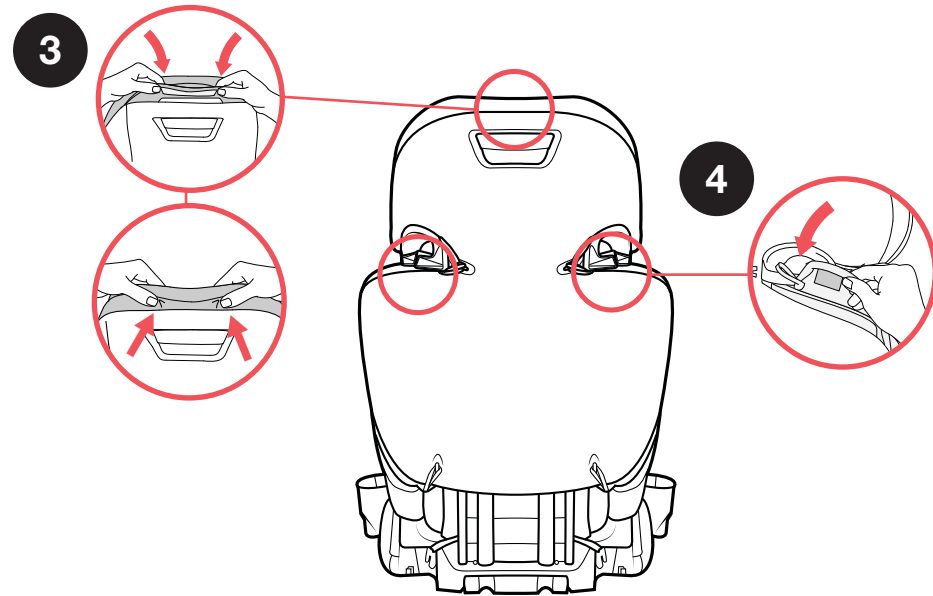

REMOVING FABRIC COVERS

The foam pad **MUST** be inserted into the seat bottom fabric, see page 74.

- 5** Position the fabric cover on the Booster Seat bottom and tuck in the fabric along the belt guide edges. Flip the seat bottom over. Then tighten the fabric over the Booster Seat bottom further by reattaching the elastic loops, as shown.

⚠ Be sure to fit fabric cover carefully around all orange belt guides. The Booster Seat must **NEVER** be used without the fabric cover. It may not perform as intended in the event of a crash.

REMOVING FABRIC COVERS

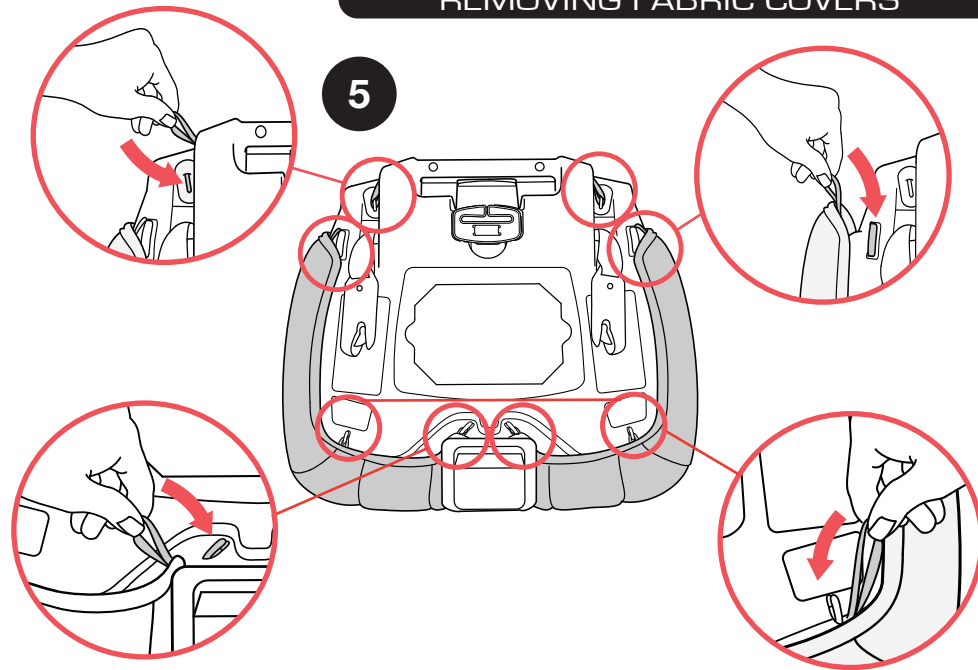

REMOVING ARMREST COVERS

1

Armrest covers

Locate the Armrest release button directly under the front of the Armrest. Pull on the button and at the same time lift up on the front edge to remove the Armrest pad.

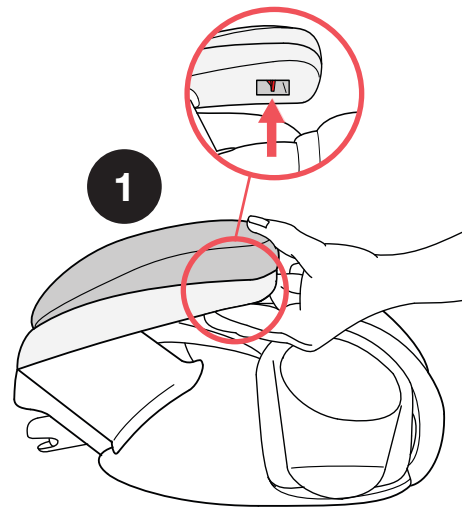

REMOVING ARMREST COVERS

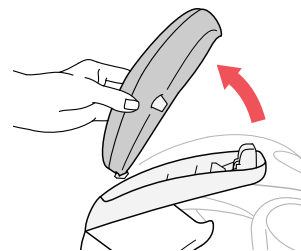

REMOVING ARMREST COVERS

- 2 Pull back on the edges of the Armrest fabric covers and slide the fabric off the Armrest base.
- 3 To reattach the Armrest, insert the Back Tab into the Armrest base and push down on the front edge until it clicks into the base.

NEVER use seat without Armrest fabric covers.

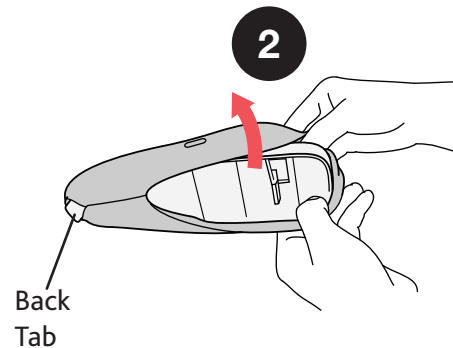

REMOVING ARMREST COVERS

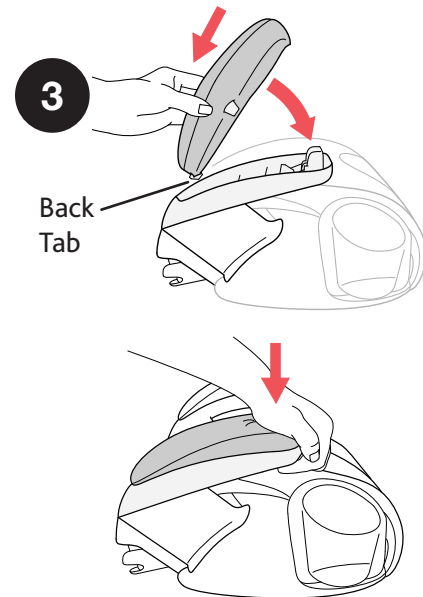

▲ DO NOT USE BLEACH, solvents or household cleaners as they may weaken plastics and straps.

▲ DO NOT USE SOAPS OR LUBRICANTS on the LATCH Connectors or straps. It may cause them to malfunction.

- **Fabrics may be spot-cleaned:**
Hand wash using mild soap and water, or machine wash in cold water on delicate cycle using mild detergent. Hang to dry. See page 72 for removal instructions.
- **Foam Insert:**
Hand rinse and air dry.
- **Cleaning Plastics:**
Sponge clean using warm water and mild soap. Towel dry.

- **Cleaning LATCH Connectors Hardware and Straps:**
LATCH Connectors hardware and straps cannot be replaced. Sponge clean using warm water. Air dry.
- **Storing the Booster:**
When it is not installed in the car, it is recommended to store the Booster in a dry place, away from sources of heat, dust, humidity and direct sunlight.

