



⚠ WARNING: Avoid serious injury or death to your child. You must read and understand the Rear-Facing instructions and the instructions in the User Guide. If you do not understand these instructions, **STOP and call Chicco at 1-877-424-4226.**

SS0041E_04

INSTRUCTIONS: Fit360™ Car Seat Mirror

IMPORTANT: Please also refer to the instructions that came with your product.

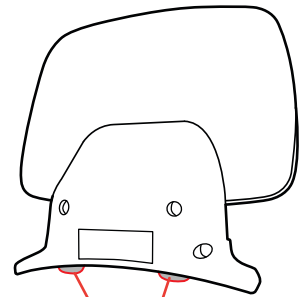
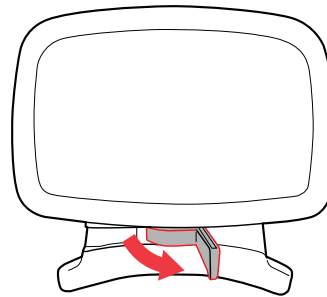
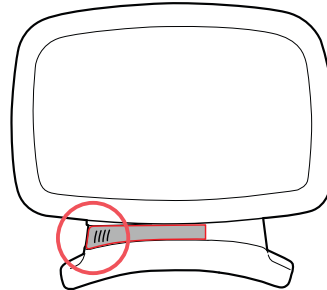
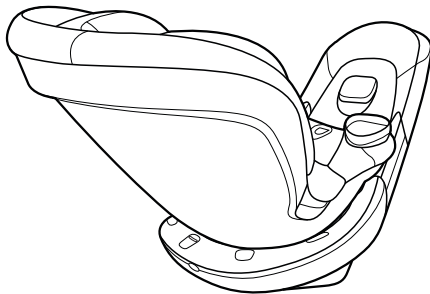
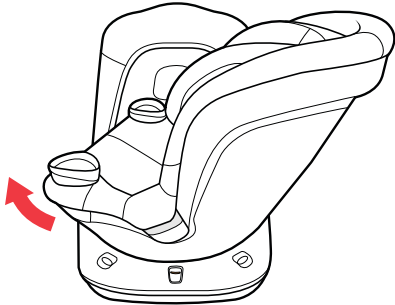

Locating Tabs

1 The Seat **MUST** be in the Rear-Facing position to allow the Car Seat Mirror to be mounted. Mirror is for Rear-Facing use **ONLY**.

2 Open the Mirror Latch by rotating the Lever past the detent to the fully open position. Locate the Mirror Locating Tabs on the bottom of the mirror, as shown.

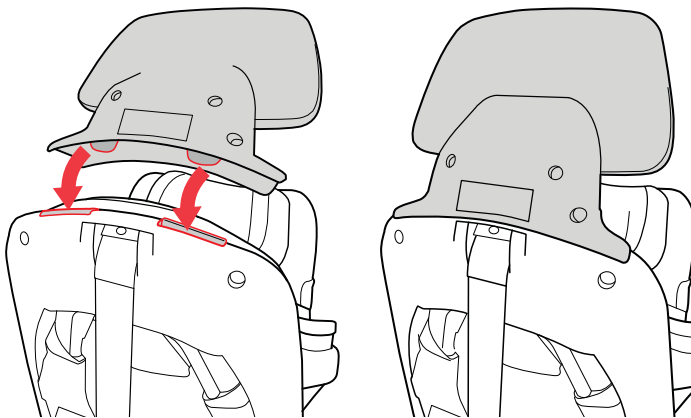

3 Align the Mirror Locating Tabs with the matching slots on the Base. Attach the Mirror to the Base, as shown.

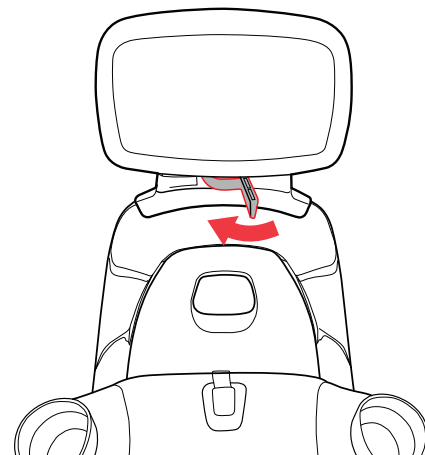

4 Close the Mirror Latch on the front of the mirror to lock the Mirror onto the base. Push the Lever past the detent to the fully closed position. Check that mirror is securely attached by pulling upward on it.

⚠️ WARNING

Avoid serious injury or death to your child.

This product is not a toy.

DO NOT allow children to play with it.

Mirror Latch must be fully closed to lock mirror in place.

Always check that the mirror is properly secured. Check frequently.

DO NOT use if broken or damaged.

Be aware that mirror can reflect sunlight and bright lights on child's eyes.

Cleaning Instructions:

To clean the mirror, wipe with clean, damp cloth. Air dry. Do not submerge in water.